



2400-2500 & 5150-5875 MHz DUAL BAND WLAN / BLUETOOTH ANTENNA

Part Numbers: 2344656-1, 2344656-2
2344656-3, 2344656-4
2344656-5, 2344656-6
2344656-7, 2344656-8

FEATURES & BENEFITS

- Adhesive backing on FPC simplifies mounting within the device
- Omnidirectional coverage
- Efficient design reduces power usage
- No matching components required
- Ground-plane independent design
- Wide selection of micro-coaxial cable lengths from 50 to 200mm

SPECIFICATIONS

Frequency Range (MHz)	2400-2500	5150-5850
VSWR	< 3.0:1	< 3.0:1
Average Efficiency	80%	80%
Peak Gain	2.5dBi	7.0dBi
Average Gain	-1.8dB	0.1dB
Power Handling	10 Watt cw	
Feed Point Impedance	50 ohms unbalanced	
Polarization	Linear	
Size	30 mm x 9.5 mm x 0.2 mm	
Weight	< 0.7 g	
Mounting	Adhesive Tape	
Mating Connector	MHF-type receptacle (TE PN 2337019-1), MHF4-type receptacle (TE PN: 2334884-1)	
Operating Temperature	-40 to +85°C	
Storage Temperature	-40 to +85°C	
Hazardous Materials	A certificate of conformance is available from the product page on TE website.	

RF DATA

VSWR

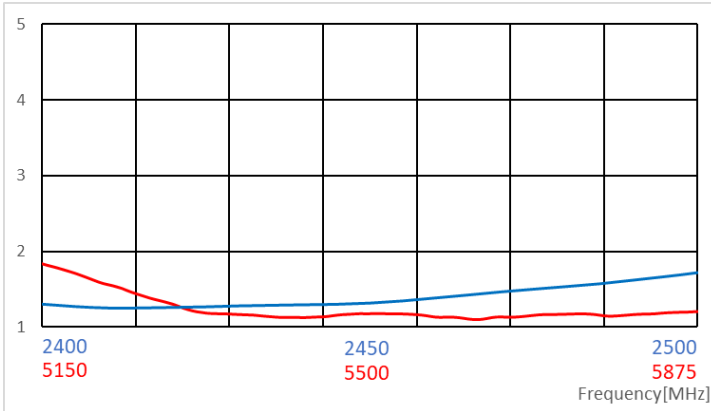

Return Loss

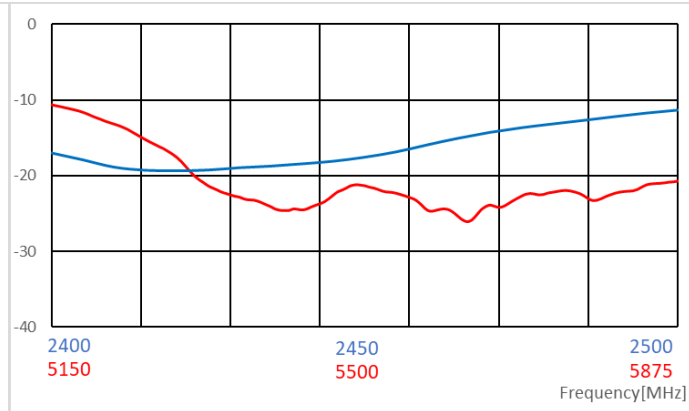

Efficiency

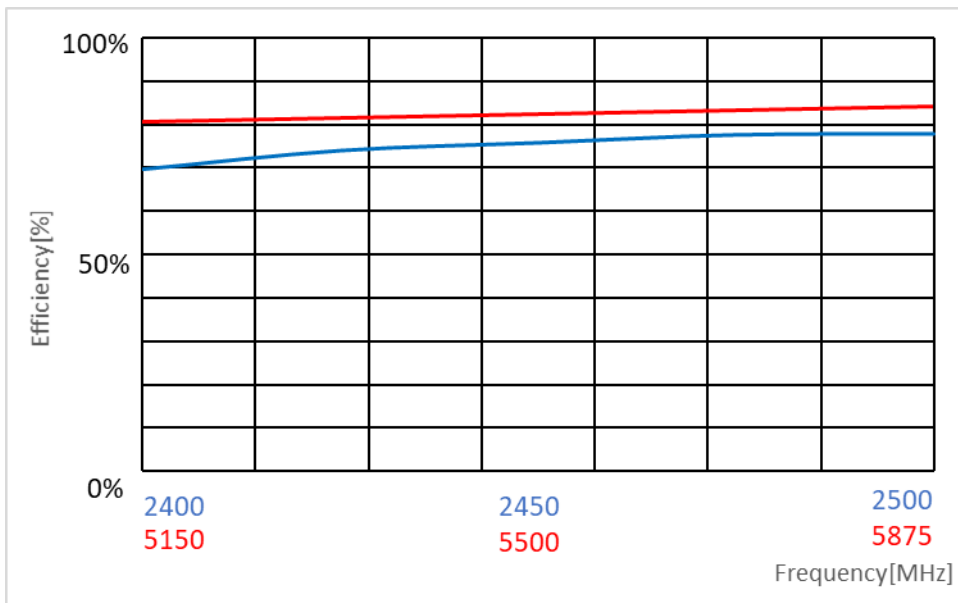

Data measured in free space and on plastic board.

RADIATION PATTERN

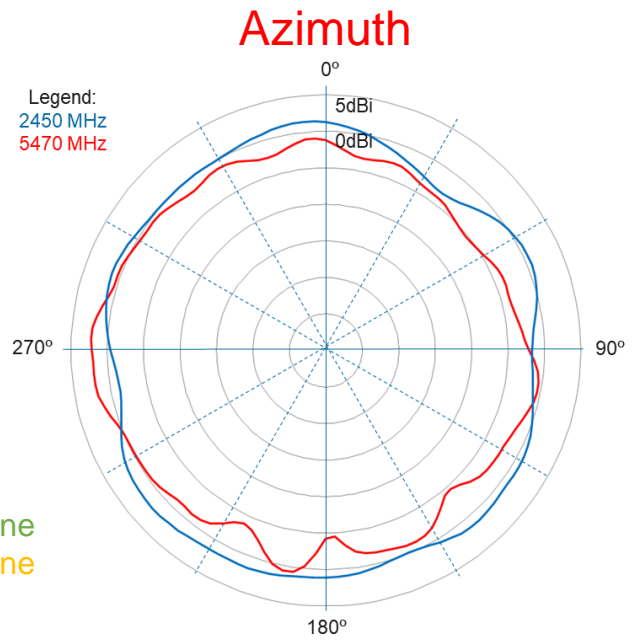
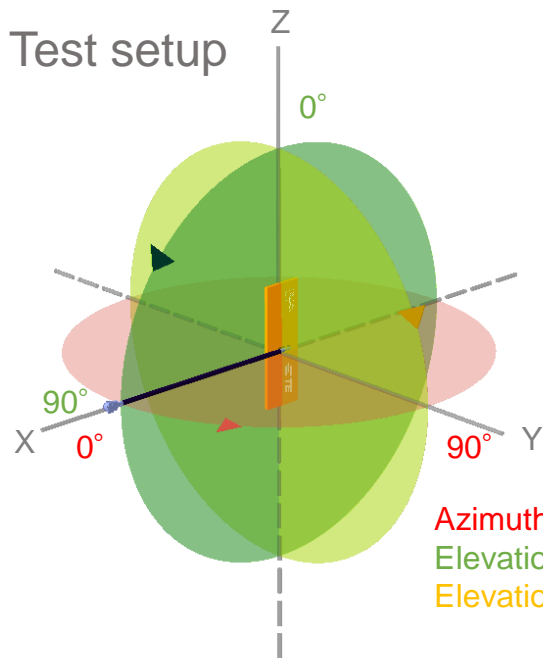

Elevation 1

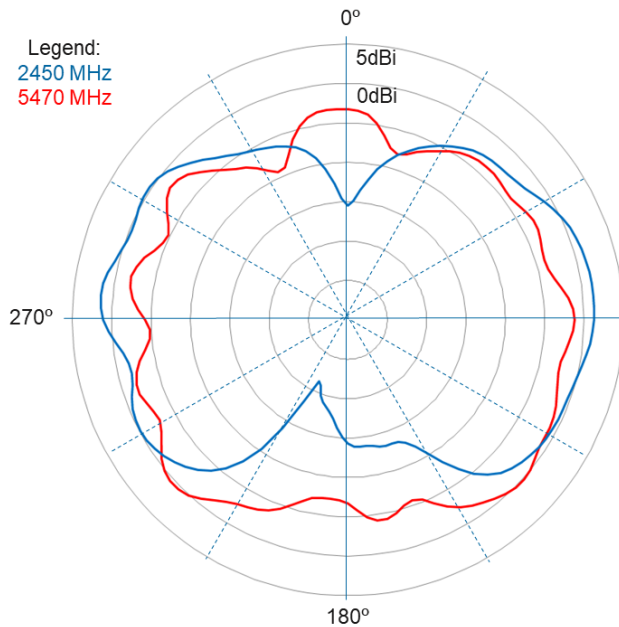

Elevation 2

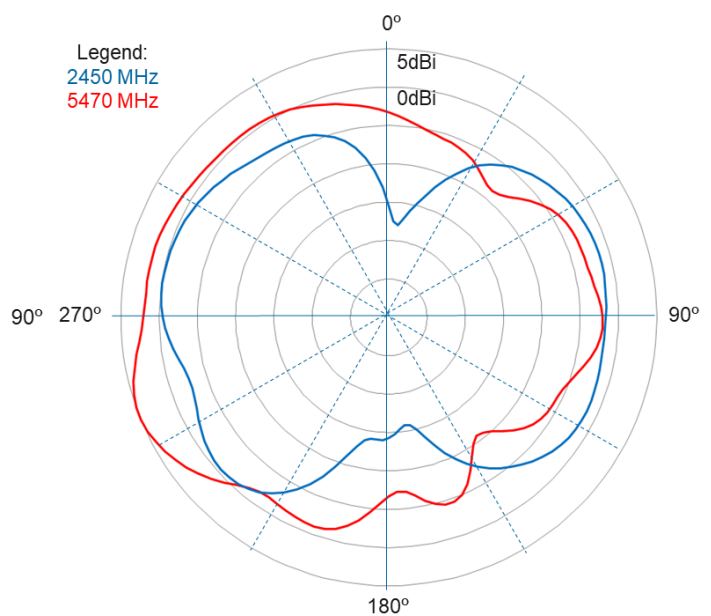

Data measured in free space and on plastic board.

DUAL BAND WLAN / BLUETOOTH ANTENNA

Standard Antenna Solutions

KEEP OUT AREA

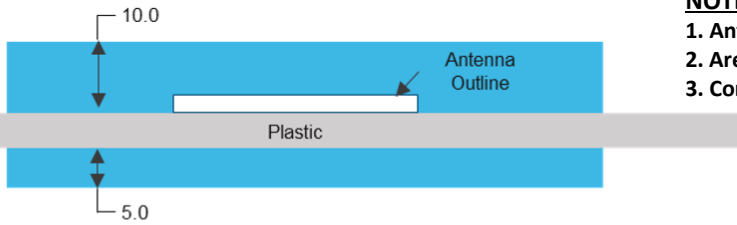

NOTES

1. Antenna designed to be mounted on plastic cover.
2. Area in blue indicates Keep Out Area
3. Contact TE if keep out zone cannot be guaranteed.

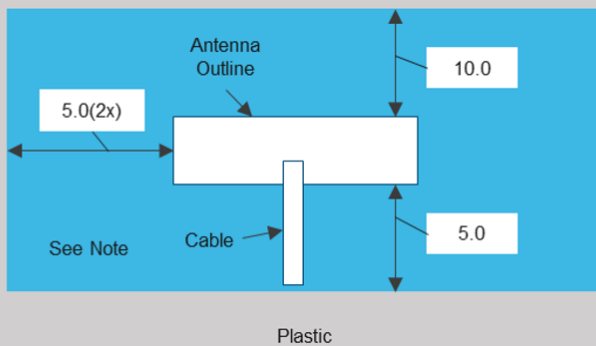

Dimension: mm
Diagrams is not into scale

DIMENSIONS

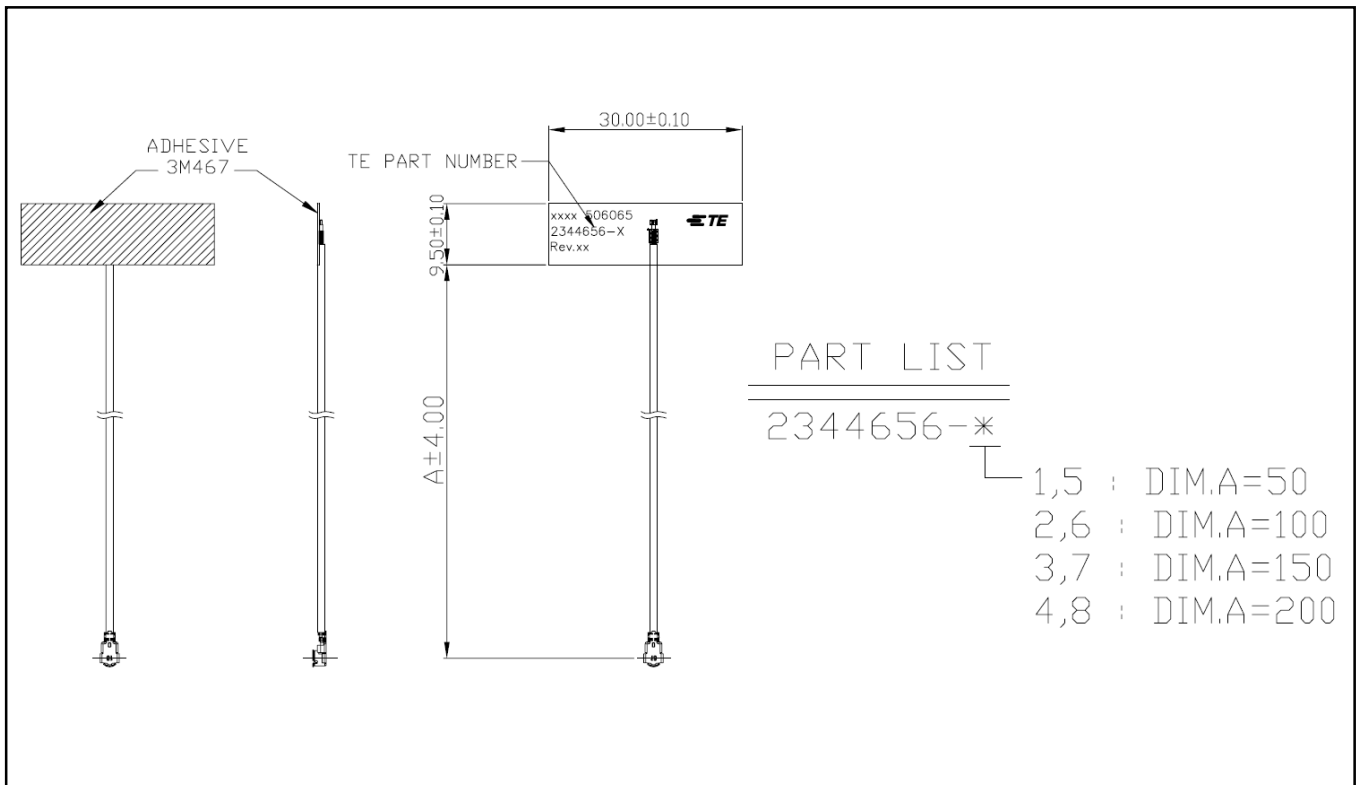

DUAL BAND WLAN / BLUETOOTH ANTENNA

Standard Antenna Solutions

MATING COMPONENTS

2344656-1	50	1.97	MHF-TYPE PLUG	RECEPTACLE (TE PN: 2337019-1)	
2344656-2	100	3.94	MHF-TYPE PLUG	RECEPTACLE (TE PN: 2337019-1)	
2344656-3	150	5.91	MHF-TYPE PLUG	RECEPTACLE (TE PN: 2337019-1)	
2344656-4	200	7.87	MHF-TYPE PLUG	RECEPTACLE (TE PN: 2337019-1)	
2344656-5	50	1.97	MHF4-TYPE PLUG	RECEPTACLE (TE PN: 2334884-1)	
2344656-6	100	3.94	MHF4-TYPE PLUG	RECEPTACLE (TE PN: 2334884-1)	
2344656-7	150	5.91	MHF4-TYPE PLUG	RECEPTACLE (TE PN: 2334884-1)	
2344656-8	200	7.87	MHF4-TYPE PLUG	RECEPTACLE (TE PN: 2334884-1)	
PART NUMBER	MM	INCH	CONNECTOR TYPE (ON CABLE)	PART NUMBER	IMAGE
	CABLE LENGTH ("A")			MATING COMPONENTS	

PACKAGING

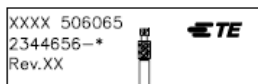

50PCS/BUNCH

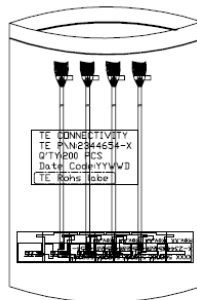

200PCS/BAG
DESICCANT:1PCS/BAG

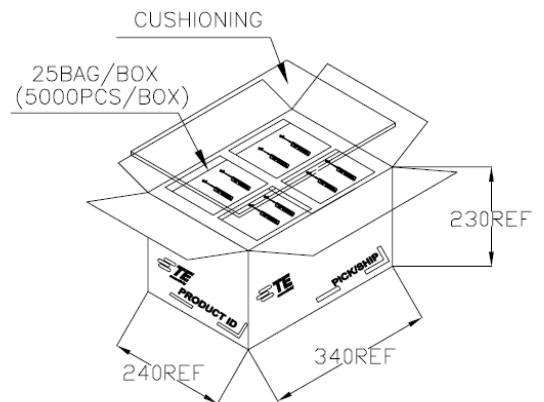

TE TECHNICAL SUPPORT CENTER

USA:	+1 (800) 522-6752
Canada:	+1 (905) 475-6222
Mexico:	+52 (0) 55-1106-0800
Latin/S. America:	+54 (0) 11-4733-2200
Germany:	+49 (0) 6251-133-1999
UK:	+44 (0) 800-267666
France:	+33 (0) 1-3420-8686
Netherlands:	+31 (0) 73-6246-999
China:	+86 (0) 400-820-6015

For phone numbers in other countries, go to te.com/support-center

te.com

TE Connectivity, TE Connectivity (logo) and Every Connection Counts are trademarks. All other logos, products and/or company names referred to herein might be trademarks of their respective owners.

The information given herein, including drawings, illustrations and schematics which are intended for illustration purposes only, is believed to be reliable. However, TE Connectivity makes no warranties as to its accuracy or completeness and disclaims any liability in connection with its use. TE Connectivity's obligations shall only be as set forth in TE Connectivity's Standard Terms and Conditions of Sale for this product and in no case will TE Connectivity be liable for any incidental, indirect or consequential damages arising out of the sale, resale, use or misuse of the product. Users of TE Connectivity products should make their own evaluation to determine the suitability of each such product for the specific application.

© 2020 TE Connectivity Ltd. family of companies All Rights Reserved.

9-1773982-3 04/20