

### 6DoF - BMI270

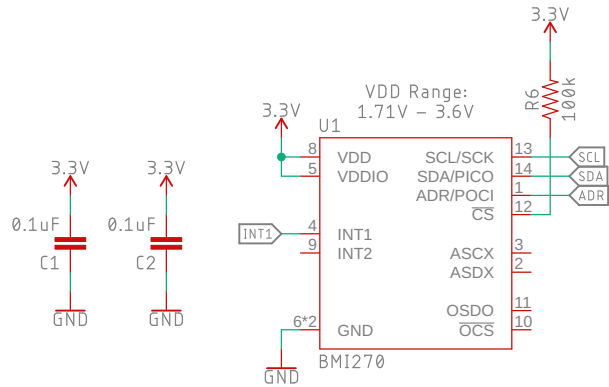

### Headers

PTH connectors only accept 22AWG or smaller

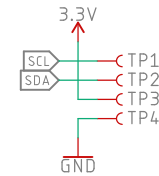
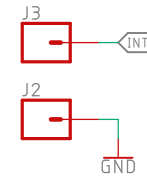

### I2C Pullups

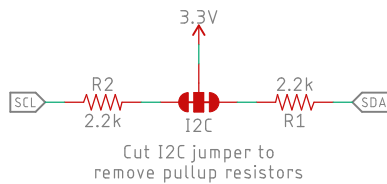

### Qwiic Connectors

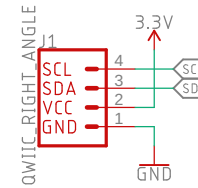

### Power LED

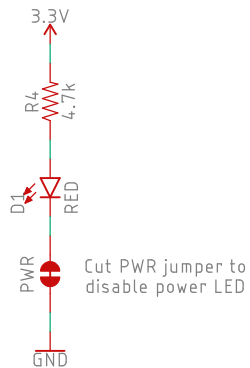

### I2C Address Selection

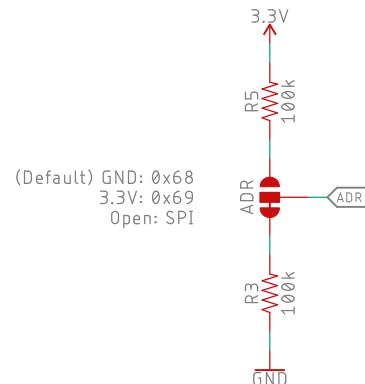

Released under the Creative Commons Attribution Share-Alike 4.0 License  
<https://creativecommons.org/licenses/by-sa/4.0/>

TITLE: SparkFun\_Qwiic\_6DoF\_BMI270

Design by: Dryw Wade  
 Original design by: Nick Poole

REV:  
v10

Date: 5/12/2023 10:29 AM

Sheet: 1/1