

Released under the Creative Commons Attribution Share-Alike 4.0 License
<https://creativecommons.org/licenses/by-sa/4.0/>

TITLE: SparkFun_Papa_Soundie_Audio_Player

Design by: Mary West
 Based on designs developed by VLSI

Date: 4/18/2018 7:05 AM

REV: v10
 Sheet: 1/2



Arduino Control

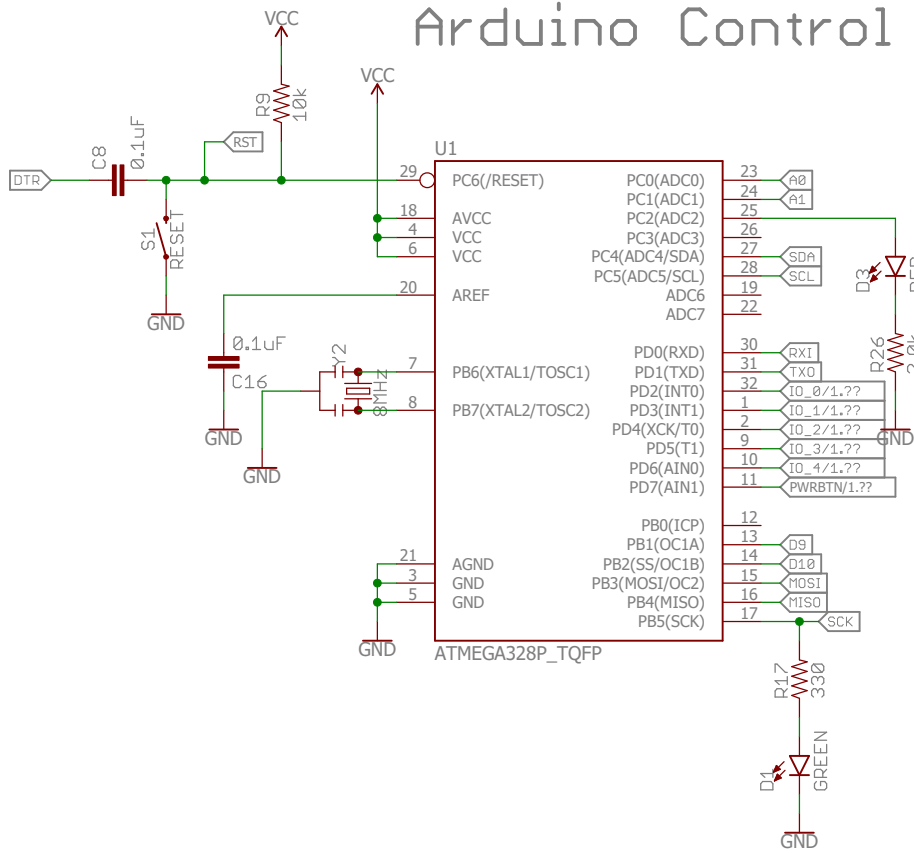

Power Supply

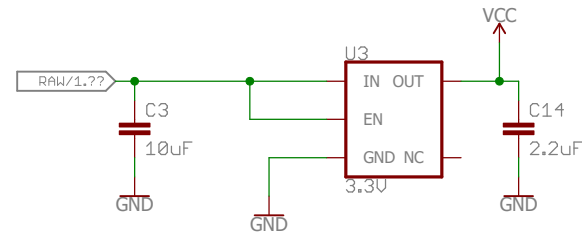

VS1000D Connectors

Left and Right AC coupled audio channels

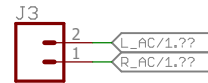

USB+ and USB- of the VLSI chip

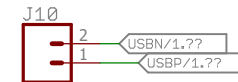

TX and RX of the VLSI chip

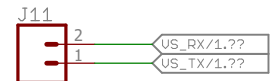

Arduino Connectors

FTDI Connector

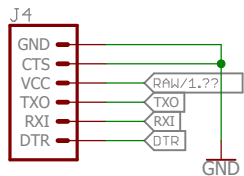

Digital IO/SPI

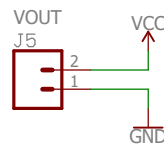
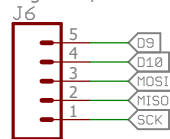

ANALOG

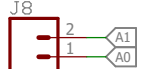

VIN

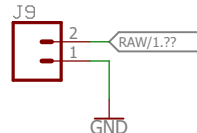

I2C

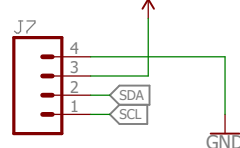

Released under the Creative Commons

Attribution Share-Alike 4.0 License

<https://creativecommons.org/licenses/by-sa/4.0/>

TITLE: SparkFun_Papa_Soundie_Audio_Player

Design by: Mary West

Based on designs developed by VLSI

REV:

v10

Date: 4/18/2018 7:05 AM

Sheet: 2/2