



4D SYSTEMS
TURNING TECHNOLOGY INTO ART

4D Universal Programming Adaptor

DATASHEET

DOCUMENT DATE: 05th MARCH 2019
DOCUMENT REVISION: 1.5

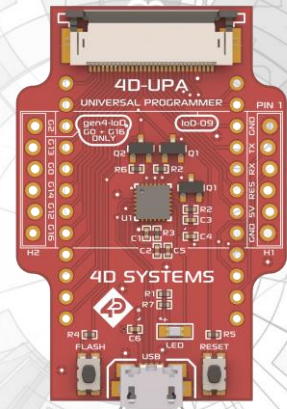

4D-UPA

Uncontrolled Copy when printed or downloaded.
Please refer to the 4D Systems website for the latest
Revision of this document

Table of Contents

1. Description	3
2. Mechanical Dimensions	4
3. Schematic Diagram	5
4. Programming Modes	6
5. Hardware Revision History	9
6. Datasheet Revision History	9
7. Legal Notice.....	10
8. Contact Information	10

1. Description

This datasheet covers the 4D-UPA (Universal Programming Adaptor) which is compatible with multiple 4D display modules. It is included in the IoD-09TH Starter Kit (SK) pack but can be sold separately, and is a quick and easy way to interface to the 4D display modules.

The 4D-UPA (Universal Programmer Adaptor) is a universal programmer designed to replace all current 4D programmers, such as the uUSB-PA5, gen4-PA, gen4-IoD-PA, and the 4D Programming Cable. It can be used for programming gen4 display modules, gen4-IoD display modules, IoD-09TH display modules, uLCD and uOLED display modules. It can also be used for interfacing to a breadboard for prototyping, or for interfacing to virtually any host.

The 4D-UPA has a 30-way FFC connector at the top of the module, for connecting to gen4-uLCD-xx display modules. On the opposite side is a 10 way FFC connector, for connecting to gen4-IoD-xx display modules. Located centrally in the larger rectangular outline, are pads associated with the gen4-uLCD-xx modules. These break out all the signals which come to/from the gen4-uLCD-xx modules. 5 of the signals are the universal 4D RESET/GND/TX/RX/5V signals, these are located together to enable interfacing/programming of the uLCD and uOLED display modules, such as the uLCD-43DT and uOLED-128G2. The outer 2 sets of 6 holes are for mounting and programming the IoD-09TH display module. The IoD-09TH pads are slightly offset, enabling a simple 'friction fit' interface to the 4D-UPA, no soldering or headers are required - although headers can be soldered if needed.

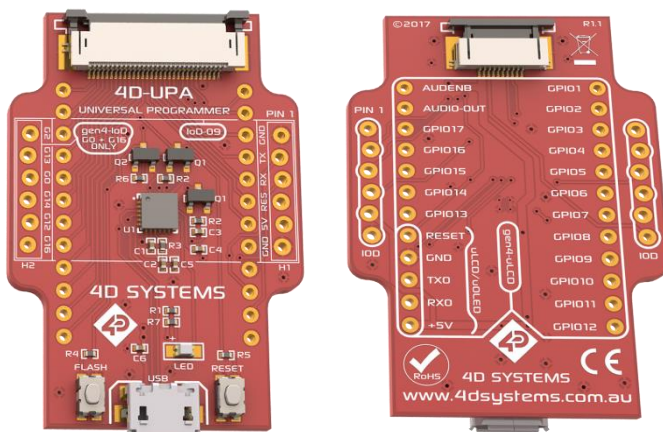

4D-UPA	DIABLO16	PICASO
GPIO1	PA3	IO1
GPIO2	PA2	IO2
GPIO3	PA1	IO3
GPIO4	PA0	IO4
GPIO5	PA9	BUS5
GPIO6	PA8	BUS4
GPIO7	PA7	BUS3
GPIO8	PA6	BUS2
GPIO9	PA5	BUS1
GPIO10	PA4	BUS0
GPIO11	PA10	BUS6
GPIO12	PA11	BUS7
GPIO13	PA12	IO5
GPIO14	PA13	RX1
GPIO15	PA14	TX1
GPIO16	PA15	I2C_SCL
GPIO17	N/C	I2C_SDA

The 4D-UPA utilises the Silicon Labs CP2104 USB to Serial Bridge IC. More information about this can be found from the Silicon Labs website. A link to the driver is available on our website.

- USB 2.0 compliant Full Speed 12Mbps maximum speed.
- Hardware or Xon/Xoff handshaking supported, 300bps to 2Mbps
- UART supports 5, 6, 7, 8 data bits, 1, 1.5, 2 stop bits, odd/even/mark/space and no parity
- Supports Windows 2000 and above, MAC (OSX-8 and above) and Linux (2.4 kernel and above)
- USB powered
- -10 to +60 degrees Celsius temp range

2. Mechanical Dimensions

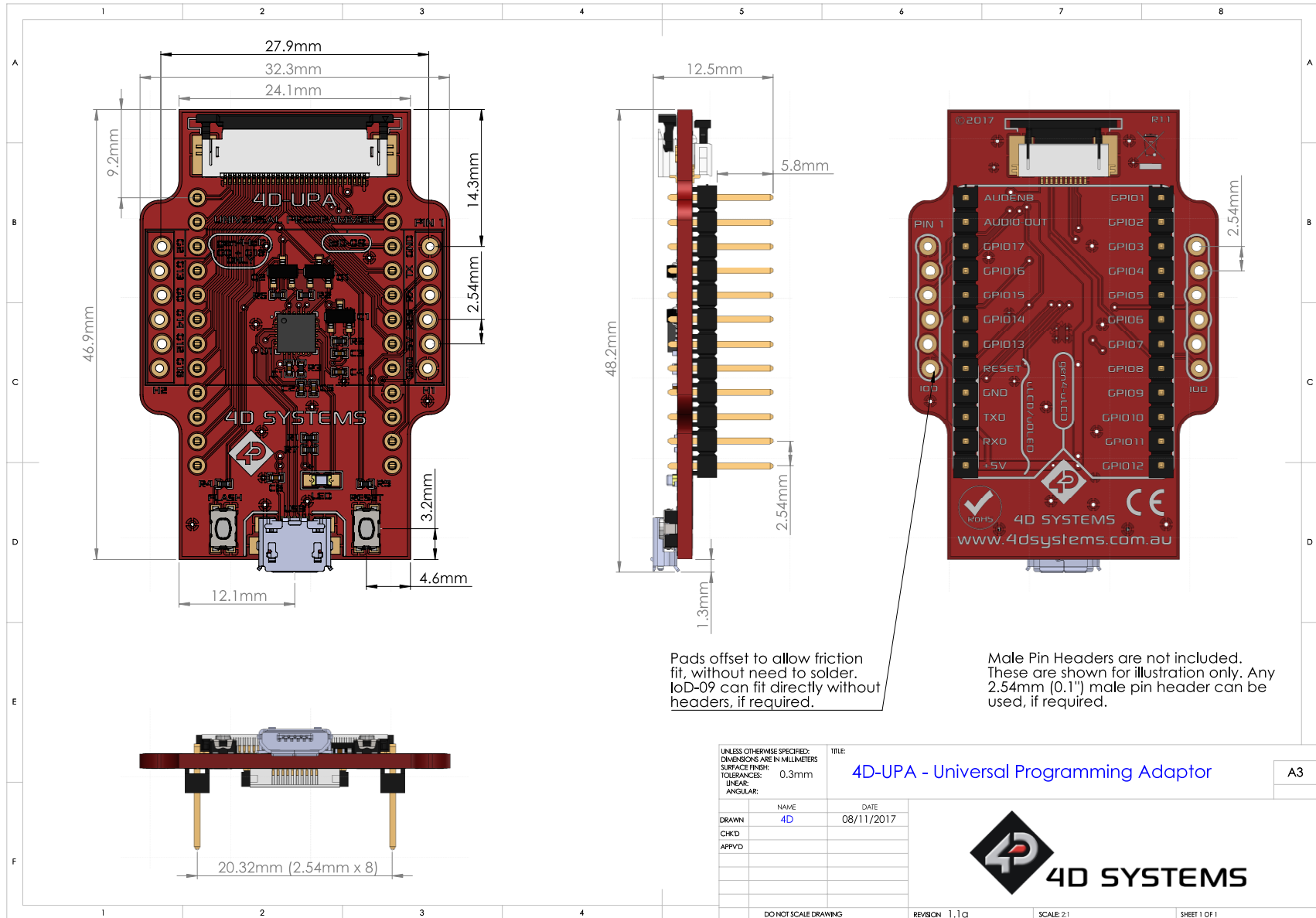

UNLESS OTHERWISE SPECIFIED: DIMENSIONS ARE IN MILLIMETERS		TITLE:		A3
SURFACE FINISH: 0.3mm		4D-UPA - Universal Programming Adaptor		
DRAWN:	NAME: 4D	DATE:	08/11/2017	
CHK'D:				
APP'VD:				
DO NOT SCALE DRAWING		REVISION: 1.1 CI	SCALE: 2:1	SHEET 1 OF 1



3. Schematic Diagram

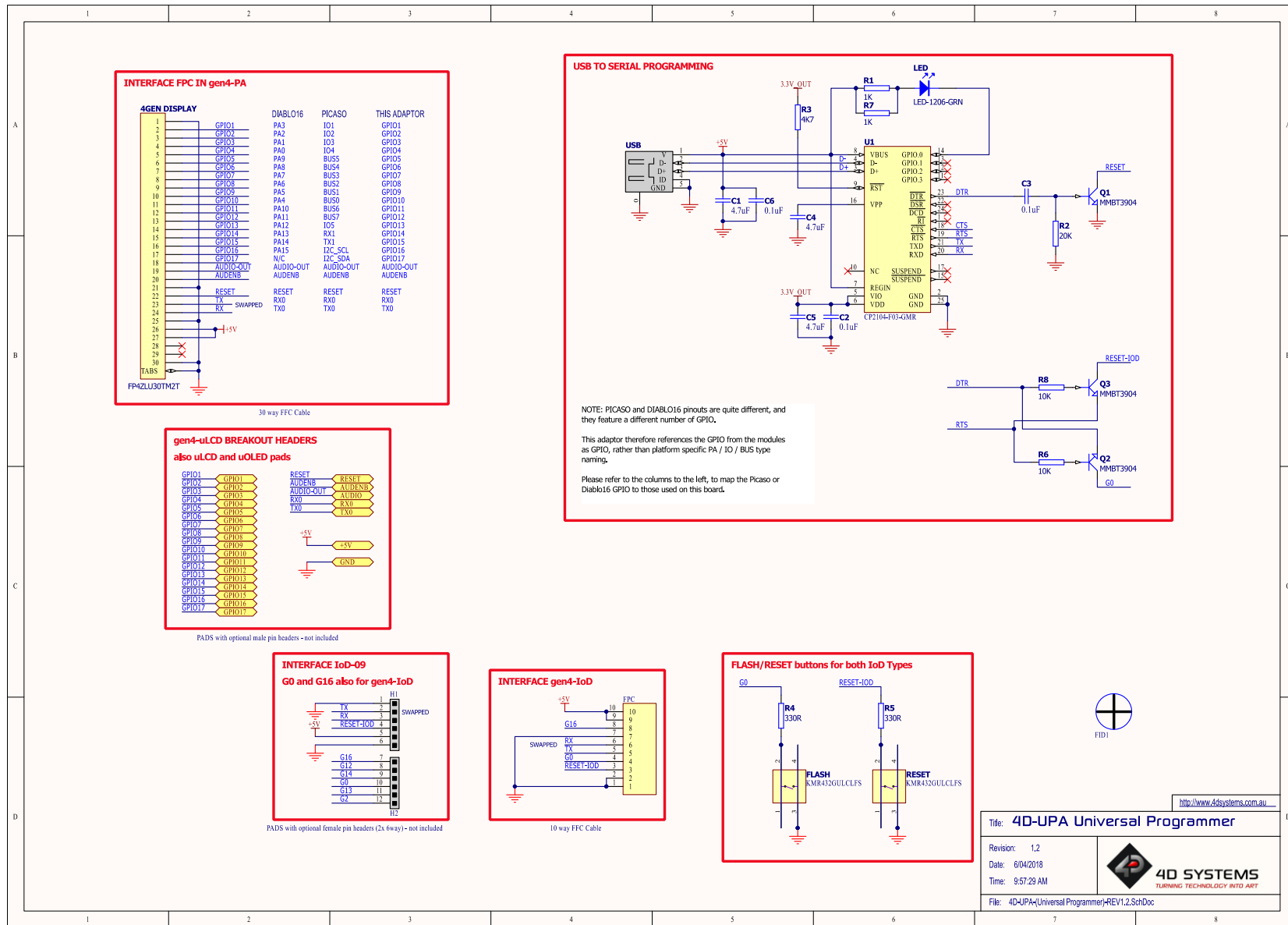

http://www.4dsystems.com.au

Title: **4D-UPA Universal Programmer**

Revision: 1.2
Date: 6/04/2018
Time: 9:57:29 AM

File: 4D-UPA-Universal Programmer-REV1.2.SchDoc

4D SYSTEMS
TURNING TECHNOLOGY INTO ART

4. Programming Modes

The following pictures show how to connect the 4D-UPA to various hardware and display modules.



Figure 1. Connection of an IoD-09TH Display module to 4D-UPA with a uUSB Cable.



Figure 2. Typical connection of gen4 display module (gen4-uLCD-43DCT-CLB) to 4D-UPA

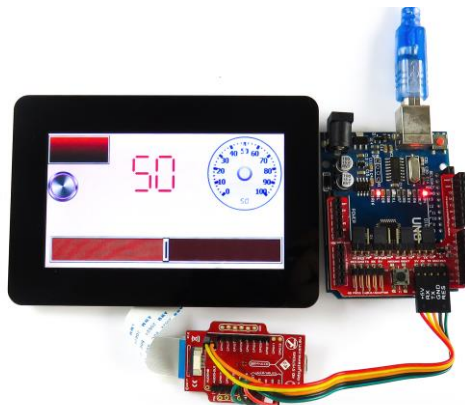

Figure 3. gen4 display (gen4-uLCD-43DCT-CLB), connected to the 4D-UPA using a 30-way FFC cable, and Jumper wires connecting to the Arduino Adaptor Shield, on top on an Arduino.

When connecting another device (such as an Arduino – shown in the previous Figure 3) to the 5-way interface pins on the 4D-UPA, while connecting a 4D Display module to the 30-way FFC, the connection to the other device (Arduino for example) utilises the UART0 serial port on the gen4 display. This is also used by the USB controller to program the gen4 display module. Therefore, each time you program to the display module, the 5-way cable needs to be disconnected to the other device (Arduino for example) so the serial UART will not have conflicts and fail. Alternatively, separately wiring to other GPIO pins on the 4D-UPA to utilise the UART1/2/3 (as is available on selected gen4 display modules) will allow this conflict to be avoided, due to utilising a separate UART. Adjustments to the settings in Workshop4 to utilise comms to a different UART, is required. The ViSi Genie Settings was changed for the previous set-up to work.

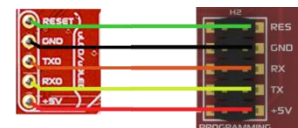
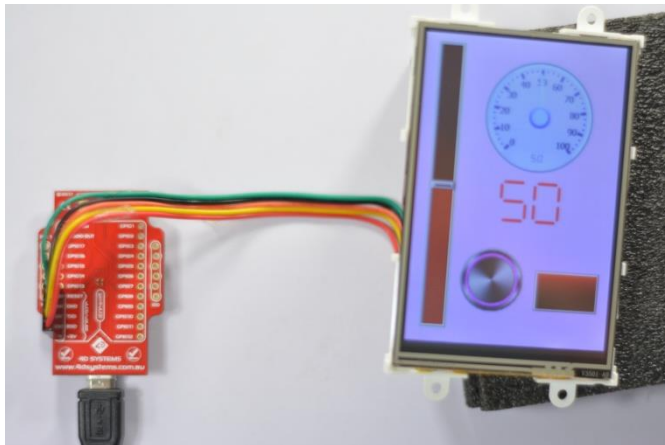
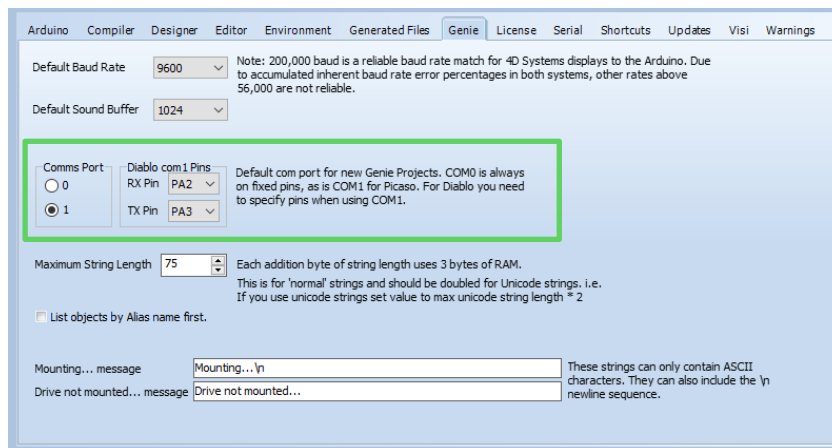

Figure 4. 4D-uLCD Display (uLCD-35DT) connected to the 4D-UPA.

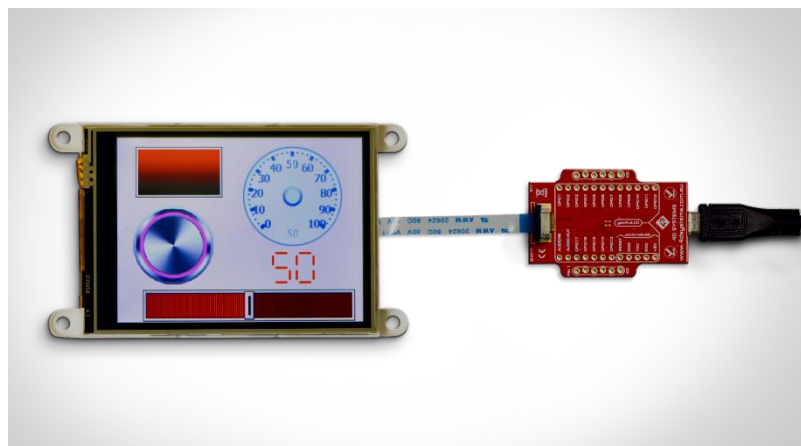

Figure 5. gen4-IoD Display (gen4-IoD-32T) connected to the 4D-UPA

The FFC cables supplied by 4D Systems (included with products) have the following specifications:

30 Pin Flexible Flat Cable, 150mm Long, 0.5mm (0.02") pitch

Cable Type: AWM 20624 80C 60V VW-1

Heat Resistance 80 Degrees Celsius

Connections on the opposite side at each end (Type B)

10 Pin Flexible Flat Cable, 150mm Long, 0.5mm (0.02") pitch

Cable Type: AWM 20624 80C 60V VW-1

Heat Resistance 80 Degrees Celsius

Connections on the opposite side at each end (Type B)

5. Hardware Revision History

Revision Number	Date	Description
1.2	31/08/2017	Initial Public Release Version

6. Datasheet Revision History

Revision Number	Date	Description
1.0	13/09/2017	Initial Draft
1.1	16/11/2017	Updated the Mechanical Dimensions
1.2	20/11/2017	Formatting change
1.3	29/11/2017	Formatting Change
1.4	09/04/2018	Addition of headers
1.5	05/03/2019	Cosmetic Changes to 4D-UPA Datasheet

7. Legal Notice

Proprietary Information

The information contained in this document is the property of 4D Systems Pty. Ltd. and may be the subject of patents pending or granted, and must not be copied or disclosed without prior written permission.

4D Systems endeavours to ensure that the information in this document is correct and fairly stated but does not accept liability for any error or omission. The development of 4D Systems products and services is continuous and published information may not be up to date. It is important to check the current position with 4D Systems. 4D Systems reserves the right to modify, update or make changes to Specifications or written material without prior notice at any time.

All trademarks belong to their respective owners and are recognised and acknowledged.

Disclaimer of Warranties & Limitation of Liability

4D Systems makes no warranty, either expressed or implied with respect to any product, and specifically disclaims all other warranties, including, without limitation, warranties for merchantability, non-infringement and fitness for any particular purpose.

Information contained in this publication regarding device applications and the like is provided only for your convenience and may be superseded by updates. It is your responsibility to ensure that your application meets with your specifications.

Images and graphics used throughout this document are for illustrative purposes only. All images and graphics used are possible to be displayed on the 4D Systems range of products, however the quality may vary.

In no event shall 4D Systems be liable to the buyer or to any third party for any indirect, incidental, special, consequential, punitive or exemplary damages (including without limitation lost profits, lost savings, or loss of business opportunity) arising out of or relating to any product or service provided or to be provided by 4D Systems, or the use or inability to use the same, even if 4D Systems has been advised of the possibility of such damages.

4D Systems products are not fault tolerant nor designed, manufactured or intended for use or resale as on line control equipment in hazardous environments requiring fail – safe performance, such as in the operation of nuclear facilities, aircraft navigation or communication systems, air traffic control, direct life support machines or weapons systems in which the failure of the product could lead directly to death, personal injury or severe physical or environmental damage ('High Risk Activities'). 4D Systems and its suppliers specifically disclaim any expressed or implied warranty of fitness for High Risk Activities.

Use of 4D Systems' products and devices in 'High Risk Activities' and in any other application is entirely at the buyer's risk, and the buyer agrees to defend, indemnify and hold harmless 4D Systems from any and all damages, claims, suits, or expenses resulting from such use. No licenses are conveyed, implicitly or otherwise, under any 4D Systems intellectual property rights.

8. Contact Information

For Technical Support: www.4dsystems.com.au/support

For Sales Support: sales@4dsystems.com.au

Website: www.4dsystems.com.au

Copyright 4D Systems Pty. Ltd. 2000-2019.