

Voltage Regulator and Battery Charger

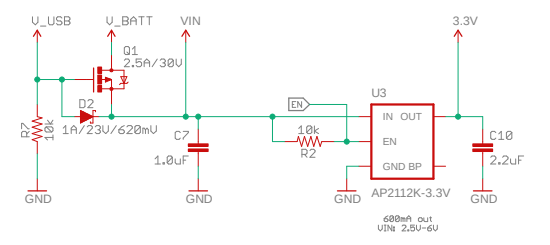

Lithium-Polymer Battery Charger (1-cell)

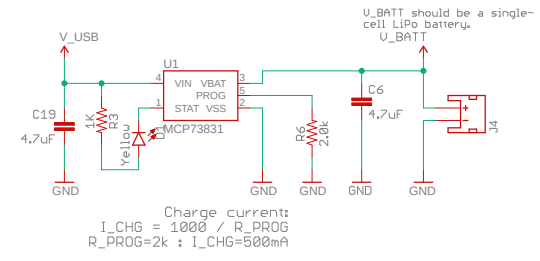

USB Connector

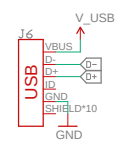

SAMD51

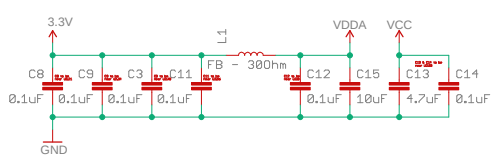
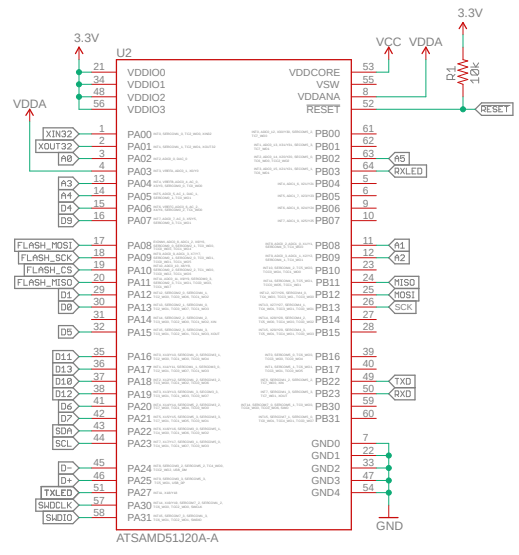
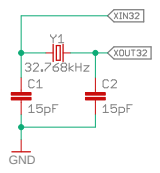

QWIC Connector

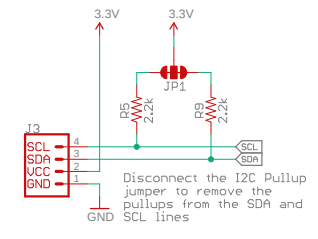

Programming Test Points

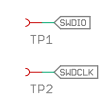

Flash Memory

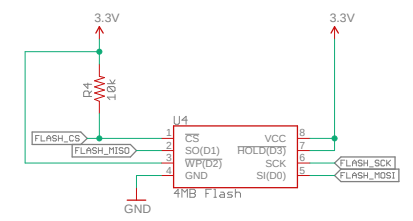

Headers

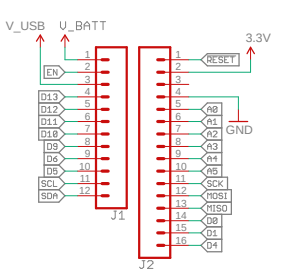

GPIO13 LED

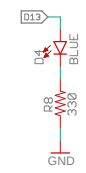

Reset Button

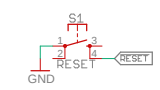

THIS IS A FOUR-LAYER BOARD!

Released under the Creative Commons Attribution Share-Alike 4.0 License
<https://creativecommons.org/licenses/by-sa/4.0/>

TITLE: SAMD51_Thing_Plus

Design by: M. Hord, M. West, A. England

Date: 5/22/2019 11:37 AM

REV: v10

Sheet: 1/1

