

RTC Backup

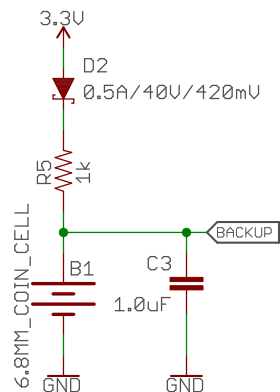

Ublox SAM-M8Q

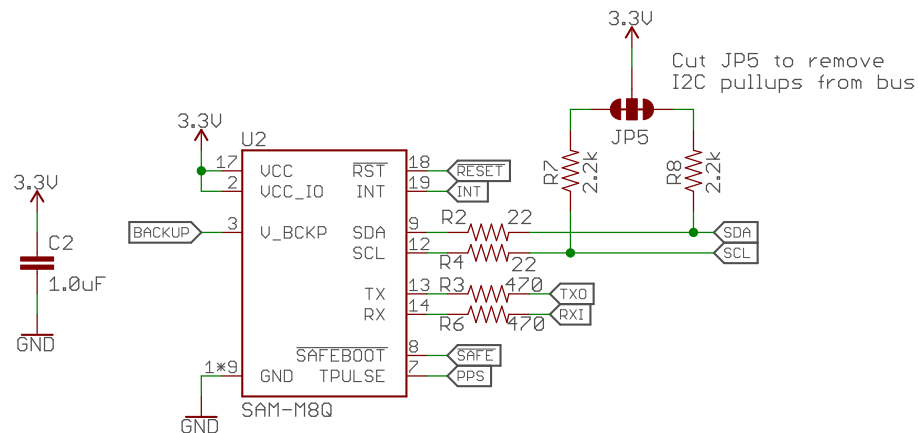

7-bit unshifted I2C address: 0x10

Pulse Per Second LED

Cut JP1 to disable PPS LED

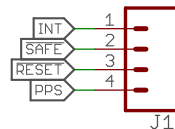
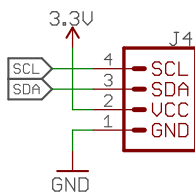
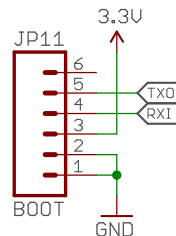
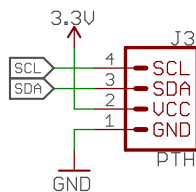
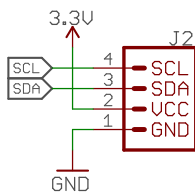
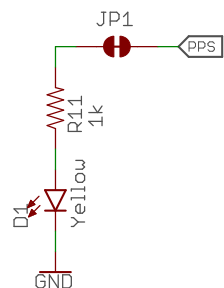

SPARK X



Released under the Creative Commons Attribution Share-Alike 4.0 License
<https://creativecommons.org/licenses/by-sa/4.0/>

TITLE: Qwiic GPS - Ublox SAM-M8Q

Design by:

REV:
V10

Date: 11/27/2018 10:16 AM

Sheet: 1/1