



Front



Back

IAA.01.121111

Specification

Iridium® Certified

Part No.	IAA.01.121111
Product Name	External Magnetic Mount Iridium Antenna
Feature	<p>1616MHz ~1626.5MHz</p> <p>Custom cables and connectors available</p> <p>Iridium® has certified the IAA.01.121111 Antenna for commercial use in connection with the Iridium Communications System</p> <p>RoHS Certified</p>

1. Introduction

The IAA.01 is a high performance magnetic mount antenna which is designed specific to communicate efficiently with the Iridium® Satellite Communication system.

The IAA.01 utilises the Taoglas expertise in ceramics by incorporating a ceramic patch tuned specifically for the antenna

environment, giving greater stability. The antenna housing is strong, corrosive proof and waterproof to IP67.

The magnetic mount allows for easy installation and removal between vehicles or assets, it is easily converted to an adhesive type for greater flexibility.

Iridium® has certified the IAA.01.121111 Antenna for commercial use in connection with the Iridium Communications System. Iridium Satellite LLC is the owner of "Iridium" and all other Iridium trademarks, service marks and logos contained herein.

2. Specification

Electrical

Frequency Range	1616Mhz~1626.5Mhz
Centre Frequency	1621.5MHz ± 5.25MHz
Bandwidth	15MHz
Impedance	50 Ohms
Polarization	RHCP
VSWR	1.5 Max (at centre frequency)
Connector	SMA(M)plug
Cable	RG-174
Termination	Ag (Environmentally-Friendly PB Free)
Operation Temperature	-40°C to + 85°C
Storage Temperature	-40°C to + 85°C
Relative Humidity	40% to 95%
Dimensions	40.5*38*12.3mm

3. Performance Measurement and Results

CH1 RFL LOG 5 dB/REF 0 dB 1: -25.868 dB 1 621.000 000 MHz
 CH3 RFL 1 U FS 1: 46.320 Ω -3.2461 Ω 30.247 pF

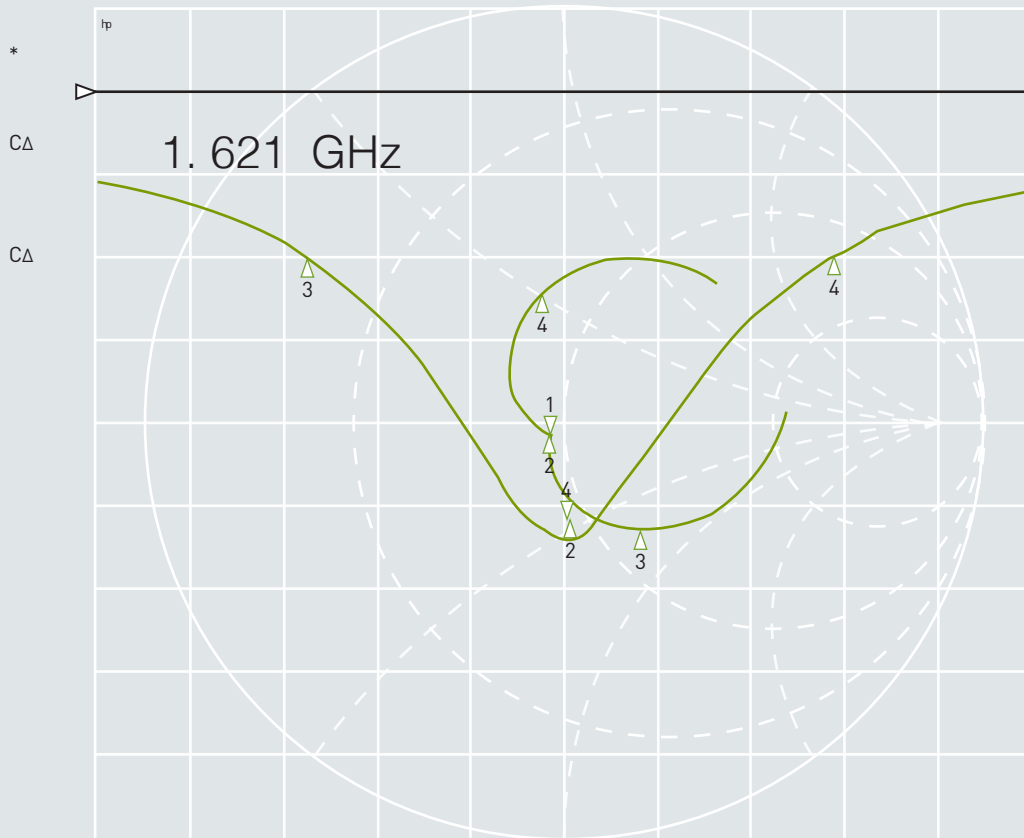

CH1 Markers
 BW: 22.553080 MHz
 cent: 1621.175680 MHz
 Q: 71.883
 1 loss: -25.868 dB

CH3 Markers
 2: 46.213 Ω
 -3.1426 Ω
 1.62117 GHz
 3: 60.857 Ω
 -35.135 Ω
 1.60989 GHz
 4: 36.963 Ω
 25.525 Ω
 1.63245 GHz

CENTER 1 621.000 000 MHz

SPAN 40.000 000 MHz

4. VSWR

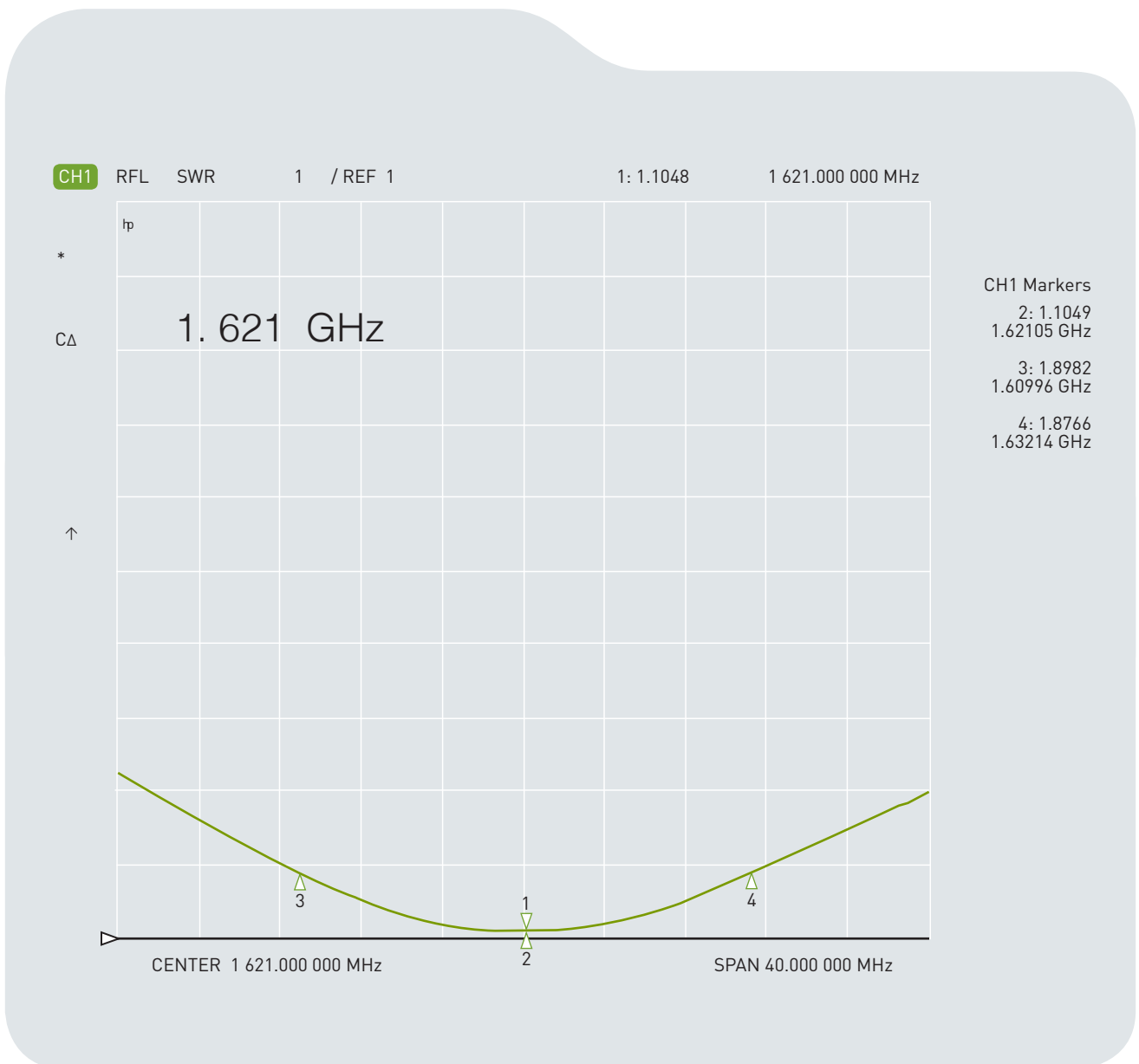

5. Antenna Gain Chart

XZ-Plane

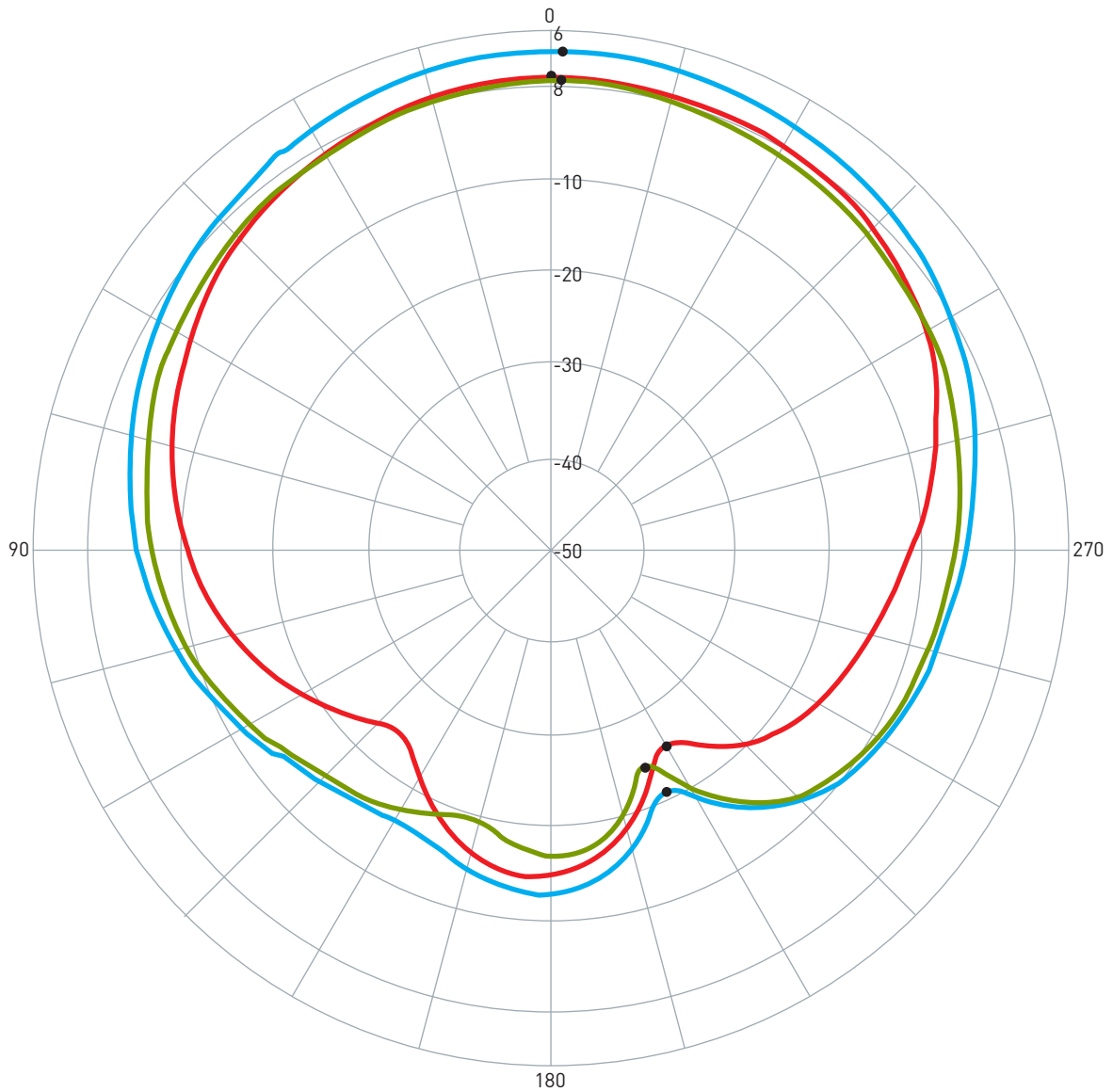

Pattern	Model No.	Test Mode	Freq (MHz)	Max Gain(dBi)	Min Gain(dBi)	Avg. Gain(dBi)	Source Polar.
1	IAA.01.121111	XZ	1621.25	0.79 / 0.00	-25.44 / 210.00	-4.69	Ver
2	IAA.01.121111	XZ	1621.25	0.64 / 359.00	-24.51 / 203.00	-4.37	Hor
3	IAA.01.121111	XZ	1621.25	3.70 / 359.00	-21.07 / 205.00	-1.52	V+H

5. Antenna Gain Chart

YZ-Plane

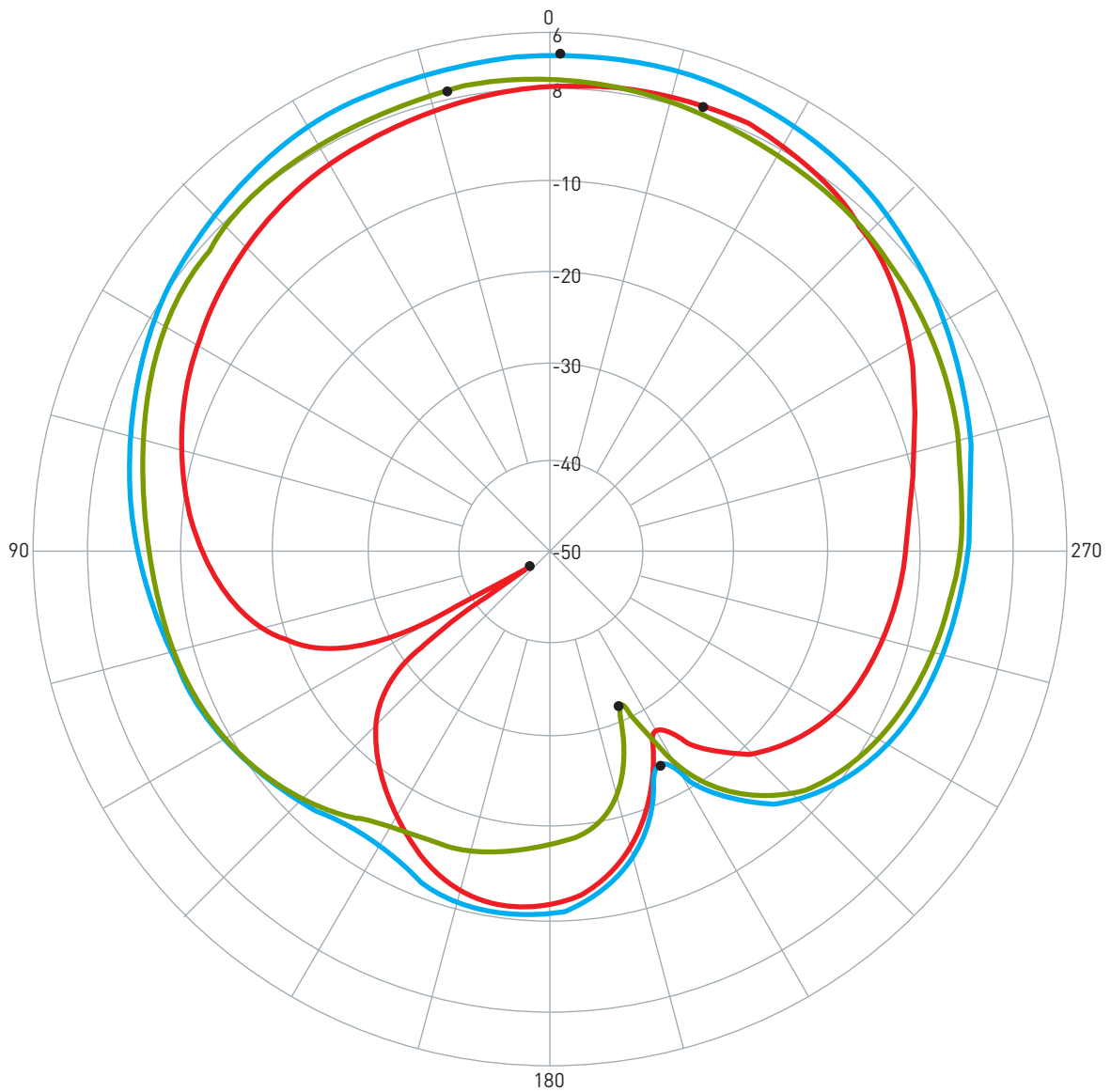

Pattern	Model No.	Test Mode	Freq (MHz)	Max Gain(dBi)	Min Gain(dBi)	Avg. Gain(dBi)	Source Polar.
1	IAA.01.121111	YZ	1621.25	0.61 / 341.00	-47.14 / 123.00	-5.35	Ver
2	IAA.01.121111	YZ	1621.25	0.78 / 13.00	-31.74 / 204.00	-3.74	Hor
2	IAA.01.121111	YZ	1621.25	3.48 / 359.00	-24.07 / 207.00	-1.46	V+H

6. Drawing

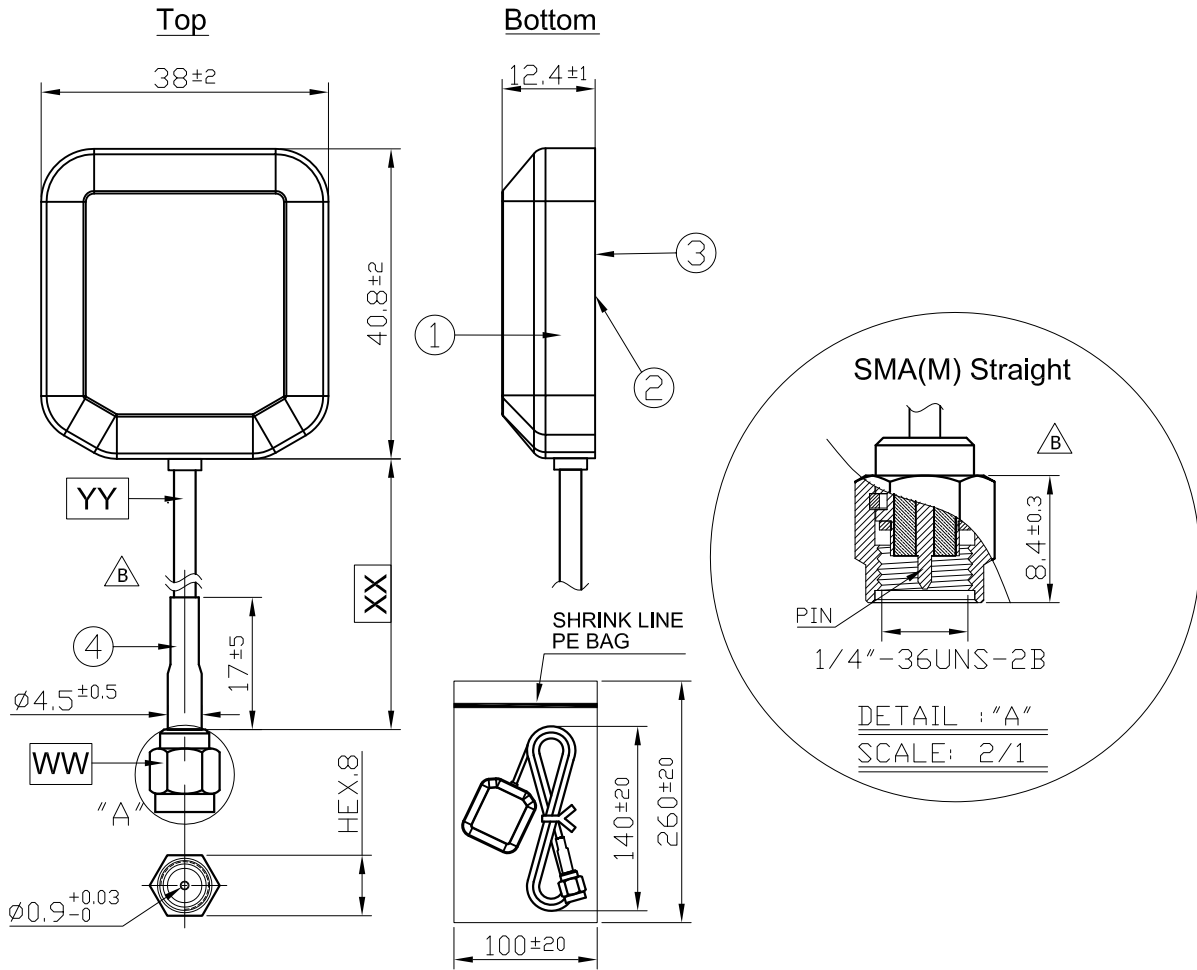

	Name	Material	Finish	QTY
1	Iridium Antenna Top	PC	Black	1
2	Iridium Antenna Bottom	PC	Black	1
3	Sticker	Coated Paper	Black	1
4	Heat Shrink Tube	PE	Black	1

	Name	Material	Finish	QTY
WW	Connector Type	SMA(M) Straight	Gold	1
XX	Cable Length	1200 ± 30 mm		1
YY	Cable Type	RG174	Black	1

7. Packing Details

100 Units / Carton

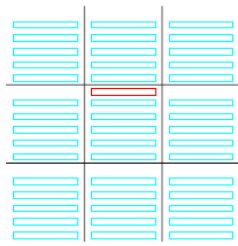

Upper Layer: 46 Pieces

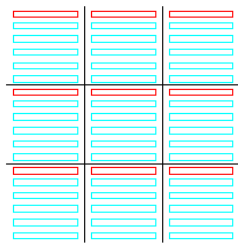

Lower Layer: 54 Pieces

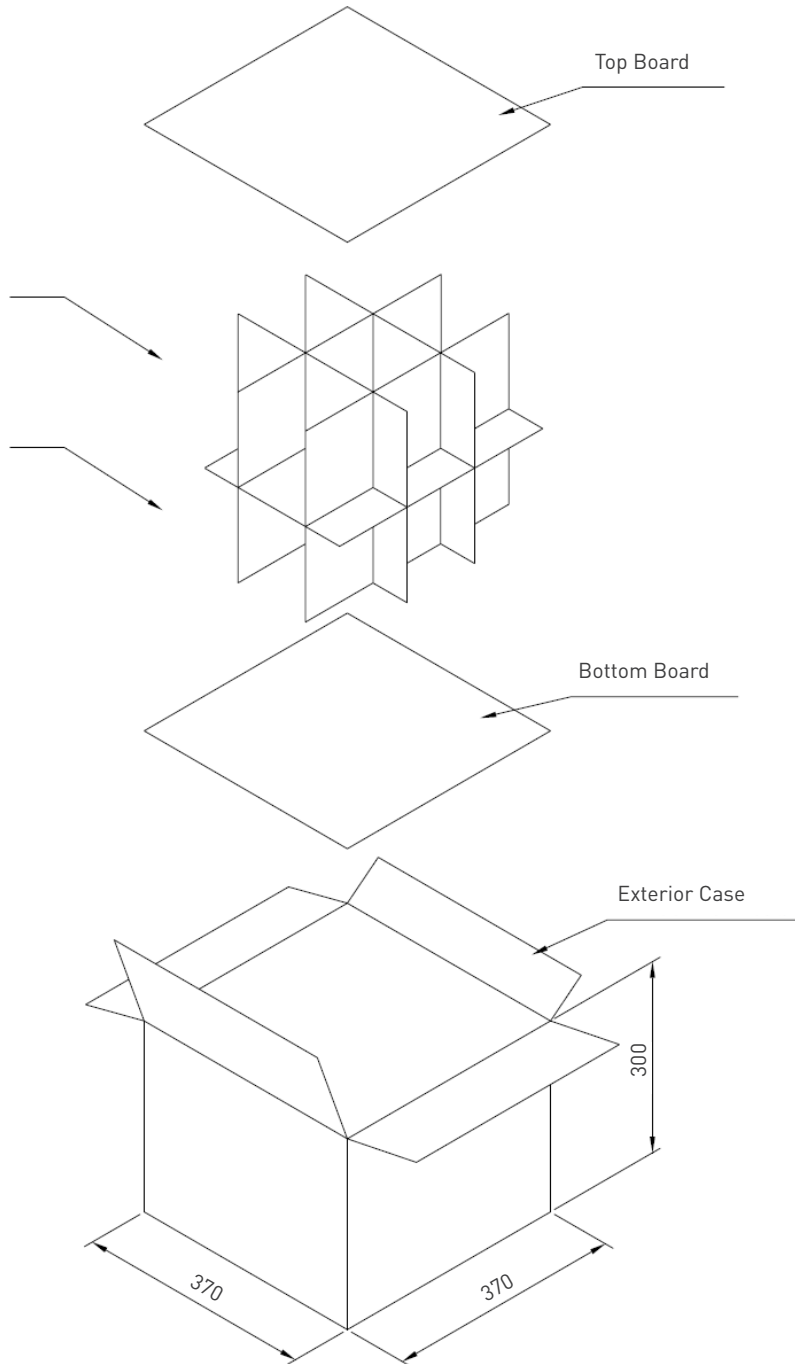

Taoglas makes no warranties based on the accuracy or completeness of the contents of this document and reserves the right to make changes to specifications and

product descriptions at any time without notice. Taoglas reserves all rights to this document and the information contained herein.

Reproduction, use or disclosure to third parties without express permission is strictly prohibited.
Copyright © Taoglas Ltd.

Mouser Electronics

Authorized Distributor

Click to View Pricing, Inventory, Delivery & Lifecycle Information:

[Taoglas:](#)

[IAA.01.121111](#)