

Hall Current 12 Click schematic v101

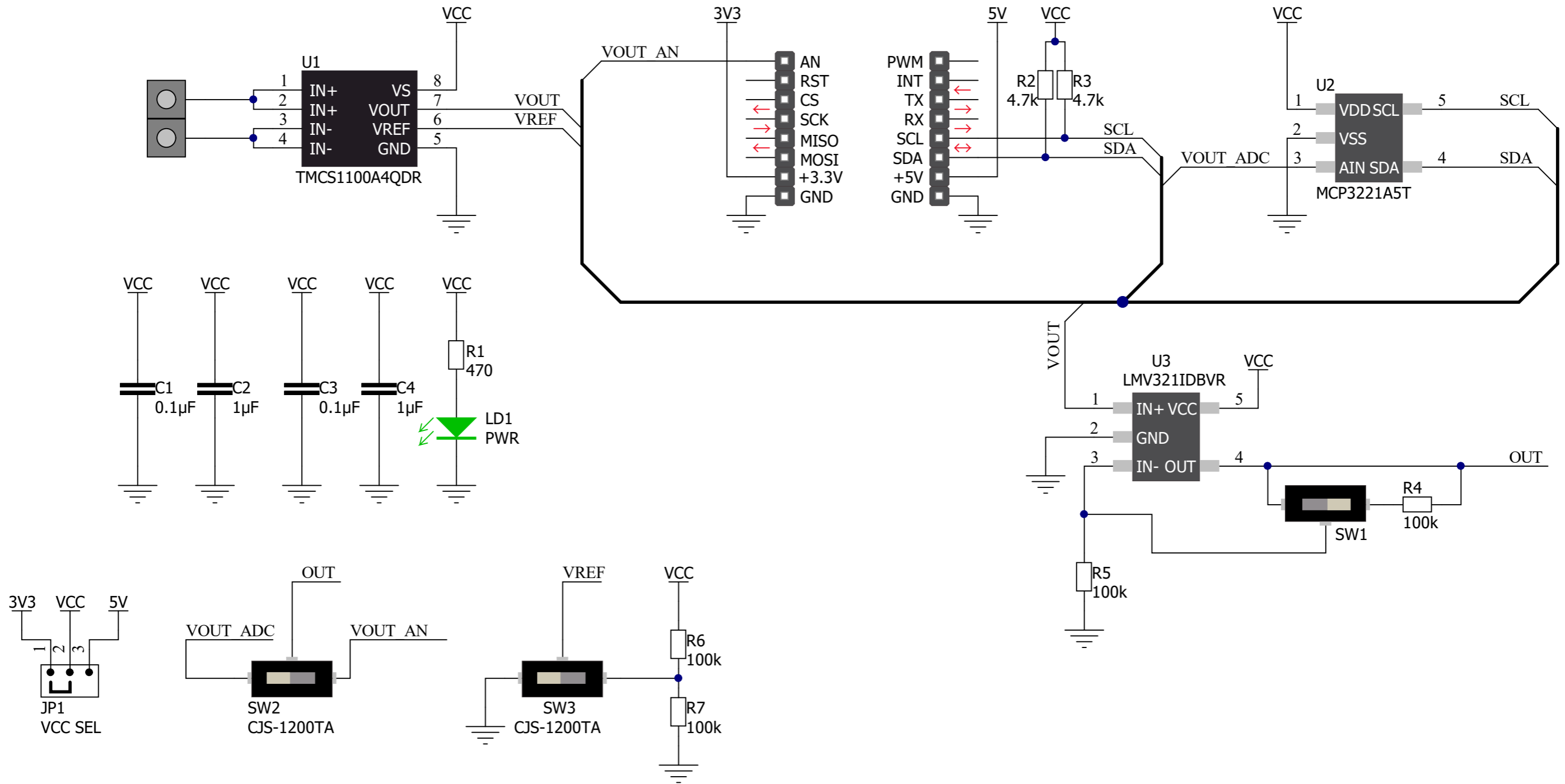

www.mikroe.com