

Accelerometer - ISM330DHCX

VDD Range: 1.71V - 3.6V
 VDDIO Range: 1.62V - 3.6V
 I2C Address (selectable): 0x6B (Default)

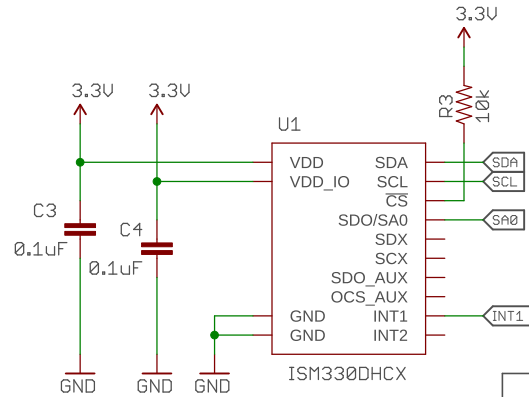

ISM330DHCX MODES
 MODE1: Peripheral-only mode
 I2C or SPI

Testpoints

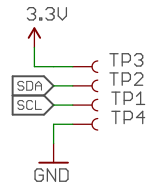

Jumpers

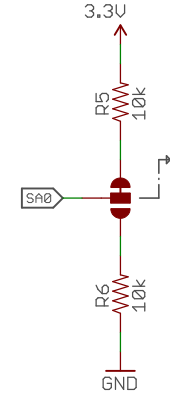
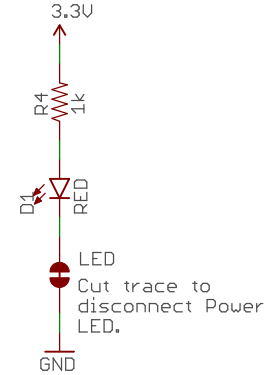

ADDR		
1	VDD	0x6B (Default)
0	GND	0x6A
	OPEN	SPI Not Supported

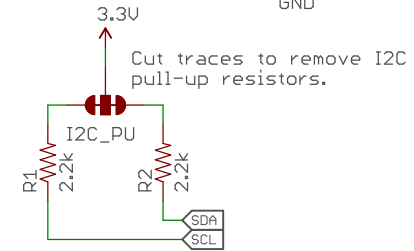

Connectors

PTH connectors only
 accept 22AWG or smaller

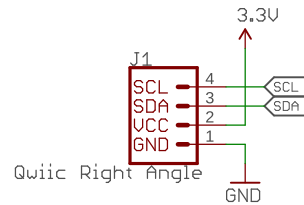
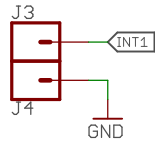

Released under the Creative Commons Attribution Share-Alike 4.0 License https://creativecommons.org/licenses/by-sa/4.0/		
TITLE: SparkFun_6DoF_ISM330DHCX_Qwiic_Micro		
Design by: Elias Santistevan		REV: v10
Date: 7/14/2022 7:31 AM	Sheet: 1/1	