

Dynamic RFID Tag – ST25DV64KC

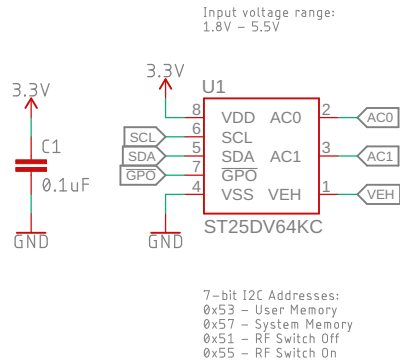

I2C Pullup

Cut traces to disable I2C pullups

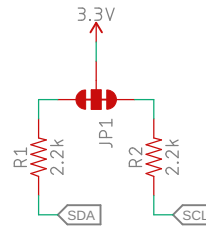

Power LED

Cut trace to disable LED

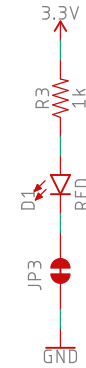

GPO Pullup

Cut trace to remove GPO pullup

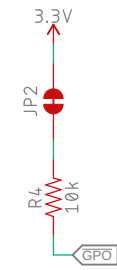

PCB antenna

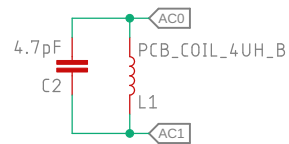

C2 may be changed to improve circuit resonance.
5.6 pF is the initial calculated value.

0.1" Header

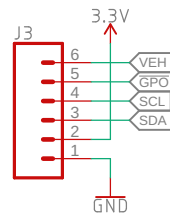

Qwiic Connectors

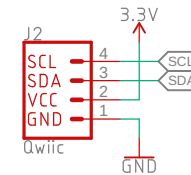
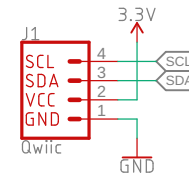

Released under the Creative Commons Attribution Share-Alike 4.0 License
<https://creativecommons.org/licenses/by-sa/4.0/>



TITLE: Qwiic_RFID_Tag

Design by: Ricardo Ramos

Revised by: Dryw Wade

Date: 2/15/2023 3:32 PM

REV:
v11

Sheet: 1/1