

### MCP9600 Thermocouple EMF to Temperature Converter

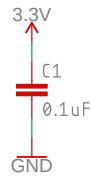

#### MCP9600 Address Selection:

- 0x60: ADDR tied to GND
- 0x61: R3 = 10k, R2 = 2.2k
- 0x62: R3 = 10k, R2 = 4.3k
- 0x63: R3 = 10k, R2 = 7.5k
- 0x64: R3 = 10k, R2 = 13k
- 0x65: R3 = 10k, R2 = 22k
- 0x66: R3 = 10k, R2 = 43k (default)
- 0x67: ADDR Pin Tied to VDD

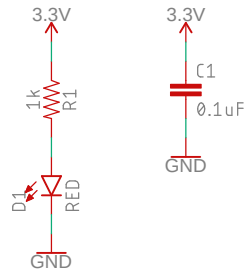
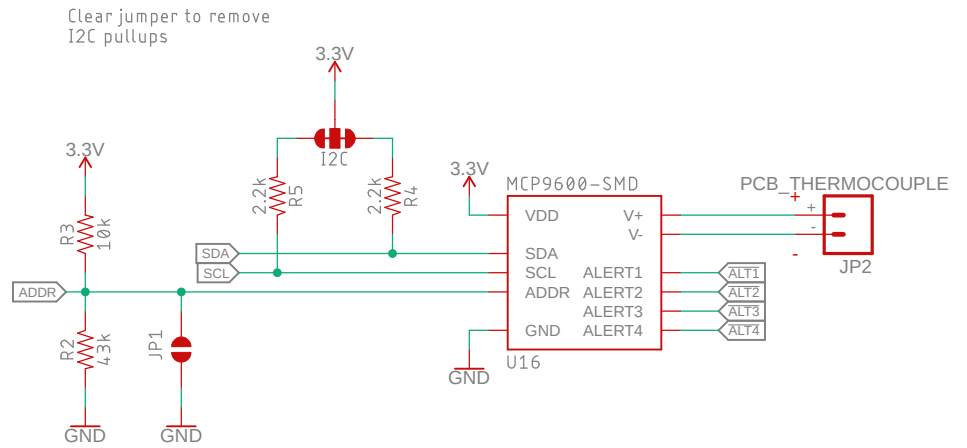

### I2C Connections

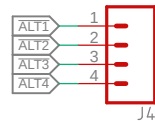
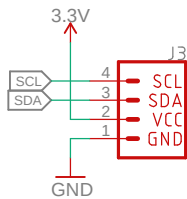
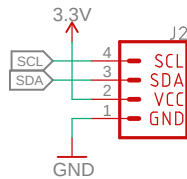
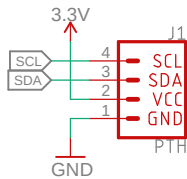

Released under the Creative Commons Attribution Share-Alike 4.0 License  
<https://creativecommons.org/licenses/by-sa/4.0/>



TITLE: Qwiic\_MCP9600

Design by: Fischer Moseley

REV: x01

Date: 7/25/2019 1:20 PM

Sheet: 1/1