

[HOME \(HTTPS://WWW.CHINADAIER.COM/\)](https://www.chinadaier.com/)   [COMPANY PROFILE](#)   [INDUSTRIES](#)   [PRODUCTS](#)

[NEWS \(HTTPS://WWW.CHINADAIER.COM/NEWS/\)](https://www.chinadaier.com/news/)   [CONTACT US \(HTTPS://WWW.CHINADAIER.COM/CONTACT-US/\)](https://www.chinadaier.com/contact-us/)

[HOME \(HTTPS://WWW.CHINADAIER.COM\)](https://www.chinadaier.com/) > [CONNECTOR \(HTTPS://WWW.CHINADAIER.COM/CATEGORY/CONNECTOR/\)](https://www.chinadaier.com/category/connector/) > [BATTERY HOLDER \(HTTPS://WWW.CHINADAIER.COM/CATEGORY/CONNECTOR/BATTERY-HOLDER/\)](https://www.chinadaier.com/category/connector/battery-holder/) > [BH18650-1001/P](#)

### CATEGORY

[PUSH BUTTON SWITCH \(HTTPS://WWW.CHINADAIER.COM/CATEGORY/PUSH-BUTTON-SWITCH/\)](https://www.chinadaier.com/category/push-button-switch/)

[ANTI-VANDAL SWITCH \(HTTPS://WWW.CHINADAIER.COM/CATEGORY/ANTI-VANDAL-SWITCH/\)](https://www.chinadaier.com/category/anti-vandal-switch/)

[MICRO SWITCH \(HTTPS://WWW.CHINADAIER.COM/CATEGORY/MICRO-SWITCH/\)](https://www.chinadaier.com/category/micro-switch/)

[TOGGLE SWITCH \(HTTPS://WWW.CHINADAIER.COM/CATEGORY/TOGGLE-SWITCH/\)](https://www.chinadaier.com/category/toggle-switch/)

[ROCKER SWITCH \(HTTPS://WWW.CHINADAIER.COM/CATEGORY/ROCKER-SWITCH/\)](https://www.chinadaier.com/category/rocker-switch/)

[SWITCH PANEL PARTS \(HTTPS://WWW.CHINADAIER.COM/CATEGORY/SWITCH-PANEL-PARTS/\)](https://www.chinadaier.com/category/switch-panel-parts/)

[AUTO SWITCH \(HTTPS://WWW.CHINADAIER.COM/CATEGORY/AUTO-SWITCH/\)](https://www.chinadaier.com/category/auto-switch/)

[OTHER SWITCH \(HTTPS://WWW.CHINADAIER.COM/CATEGORY/OTHER-SWITCH/\)](https://www.chinadaier.com/category/other-switch/)

[TACT SWITCH \(HTTPS://WWW.CHINADAIER.COM/CATEGORY/TACT-SWITCH/\)](https://www.chinadaier.com/category/tact-switch/)

[INDICATOR LIGHT \(HTTPS://WWW.CHINADAIER.COM/CATEGORY/INDICATOR-LIGHT/\)](https://www.chinadaier.com/category/indicator-light/)

[FUSE HOLDER \(HTTPS://WWW.CHINADAIER.COM/CATEGORY/FUSE-HOLDER/\)](https://www.chinadaier.com/category/fuse-holder/)

[POWER OUTLET \(HTTPS://WWW.CHINADAIER.COM/CATEGORY/POWER-OUTLET/\)](https://www.chinadaier.com/category/power-outlet/)

[KNOB \(HTTPS://WWW.CHINADAIER.COM/CATEGORY/KNOB/\)](https://www.chinadaier.com/category/knob/)

[ALUMINIUM ENCLOSURE \(HTTPS://WWW.CHINADAIER.COM/CATEGORY/ALUMINIUM-ENCLOSURE/\)](https://www.chinadaier.com/category/aluminium-enclosure/)

[CONNECTOR \(HTTPS://WWW.CHINADAIER.COM/CATEGORY/CONNECTOR/\)](https://www.chinadaier.com/category/connector/)

### RECENT PRODUCT



[BH5-3010 \(https://www.chinadaier.com/battery-retainer-bh5-3010/\)](https://www.chinadaier.com/battery-retainer-bh5-3010/)

 July 20, 2017

[\(https://www.chinadaier.com/battery-retainer-bh5-3010/\)](https://www.chinadaier.com/battery-retainer-bh5-3010/)

We're offline  
Leave a message



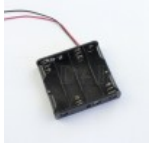

BH5-4001 (<https://www.chinadaier.com/4-aa-battery-holder-bh5-4001/>)

📅 July 21, 2017

(<https://www.chinadaier.com/4-aa-battery-holder-bh5-4001/>)



BH2032-5 (<https://www.chinadaier.com/cr2032-battery-holder-bh2032-5/>)

📅 August 10, 2017

(<https://www.chinadaier.com/cr2032-battery-holder-bh2032-5/>)



BH7-2001 (<https://www.chinadaier.com/aaa-battery-holder-bh7-2001/>)

📅 July 19, 2017

(<https://www.chinadaier.com/aaa-battery-holder-bh7-2001/>)



BH18650-4001 (<https://www.chinadaier.com/18650-4-battery-holder-bh18650-3001/>)

📅 July 21, 2017

(<https://www.chinadaier.com/18650-4-battery-holder-bh18650-3001/>)



BH5-2001 (<https://www.chinadaier.com/bh5-2001-3v-battery-holder/>)

📅 June 27, 2017

(<https://www.chinadaier.com/bh5-2001-3v-battery-holder/>)

We're offline  
Leave a message



BH18650-1001/P

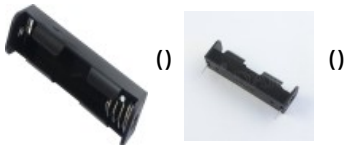

CATEGORY : Battery Holder (<https://www.chinadaier.com/category/connector/battery-holder/>)

INQUIRY NOW

### Specification

#### **BH18650-1001/P 18650 battery holder:**

BH18650-1001/P 18650 battery holder is a 3.7V 1 cell 18650 with 150mm length wire or PCB.

The holder is Holder for lithium 1X18650 Cell.

The standard color is black, but we also can customize other color for you.

The standard package is 100pcs per bag.

Most of customer used them in the toy for children and electronic equipment and so on.

Pls check the datasheet below:

Housing Material:	ABS	Metal Material:	Nickel-plated spring steel
-------------------	-----	-----------------	----------------------------

We're offline

Leave a message



Color:	Black	Battery Size:	18650
Termination:	Wire or PCB	With Switch:	No
Wire:	Standard UL1007 150mm	With Cover:	No
Operating Temperature:	-25°C~+85°C	OEM or ODM:	Available

标记	日期	姓名	变更内容
▲			

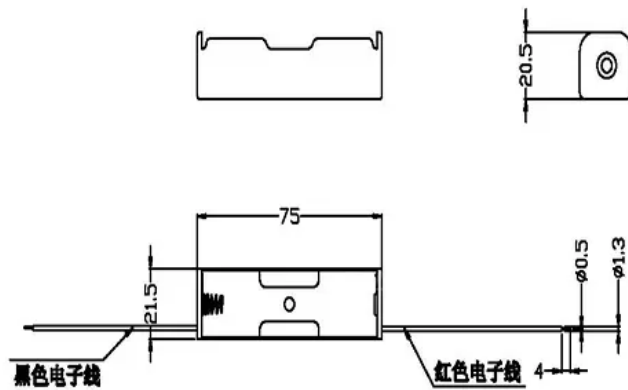

<table border="1"> <tr> <td>5</td> <td>红/黑电子线</td> <td></td> </tr> <tr> <td>4</td> <td>弹簧</td> <td>钢丝</td> </tr> <tr> <td>3</td> <td>接触片</td> <td>铁</td> </tr> <tr> <td>2</td> <td>外壳</td> <td>ABS</td> </tr> <tr> <td>1</td> <td>底座</td> <td>ABS</td> </tr> </table>	5	红/黑电子线		4	弹簧	钢丝	3	接触片	铁	2	外壳	ABS	1	底座	ABS	<table border="1"> <tr> <td>来柱公差尺寸</td> <td> <table border="1"> <tr> <td>&gt;0-4</td> <td>±0.05</td> </tr> <tr> <td>&gt;4-20</td> <td>±0.1</td> </tr> <tr> <td>&gt;20-50</td> <td>±0.1</td> </tr> <tr> <td>&gt;50-100</td> <td>±0.1</td> </tr> <tr> <td>&gt;100</td> <td>±0.1</td> </tr> <tr> <td>角度尺寸</td> <td>±2°</td> </tr> </table> </td> </tr> <tr> <td>设计</td> <td></td> </tr> <tr> <td>审核</td> <td></td> </tr> <tr> <td>批准</td> <td></td> </tr> <tr> <td>生效时间</td> <td></td> </tr> </table>	来柱公差尺寸	<table border="1"> <tr> <td>&gt;0-4</td> <td>±0.05</td> </tr> <tr> <td>&gt;4-20</td> <td>±0.1</td> </tr> <tr> <td>&gt;20-50</td> <td>±0.1</td> </tr> <tr> <td>&gt;50-100</td> <td>±0.1</td> </tr> <tr> <td>&gt;100</td> <td>±0.1</td> </tr> <tr> <td>角度尺寸</td> <td>±2°</td> </tr> </table>	>0-4	±0.05	>4-20	±0.1	>20-50	±0.1	>50-100	±0.1	>100	±0.1	角度尺寸	±2°	设计		审核		批准		生效时间		<table border="1"> <tr> <td colspan="2">名称</td> <td colspan="2">型号:</td> </tr> <tr> <td colspan="2">BH18650-1001</td> <td colspan="2">料号:</td> </tr> <tr> <td colspan="2">电池盒</td> <td>模具编号</td> <td>单位: MM 比例: 1:1</td> </tr> <tr> <td colspan="2"></td> <td>版本: A1</td> <td>视角: ② ③</td> </tr> <tr> <td colspan="2"></td> <td colspan="2">第 1 页 共 1 页</td> </tr> <tr> <td colspan="4">            乐清市康尔电子有限公司            YUBATING WATER ELECTRON CO., LTD         </td> </tr> </table>	名称		型号:		BH18650-1001		料号:		电池盒		模具编号	单位: MM 比例: 1:1			版本: A1	视角: ② ③			第 1 页 共 1 页		乐清市康尔电子有限公司 YUBATING WATER ELECTRON CO., LTD			
	5	红/黑电子线																																																													
	4	弹簧	钢丝																																																												
	3	接触片	铁																																																												
	2	外壳	ABS																																																												
1	底座	ABS																																																													
来柱公差尺寸	<table border="1"> <tr> <td>&gt;0-4</td> <td>±0.05</td> </tr> <tr> <td>&gt;4-20</td> <td>±0.1</td> </tr> <tr> <td>&gt;20-50</td> <td>±0.1</td> </tr> <tr> <td>&gt;50-100</td> <td>±0.1</td> </tr> <tr> <td>&gt;100</td> <td>±0.1</td> </tr> <tr> <td>角度尺寸</td> <td>±2°</td> </tr> </table>	>0-4	±0.05	>4-20	±0.1	>20-50	±0.1	>50-100	±0.1	>100	±0.1	角度尺寸	±2°																																																		
>0-4	±0.05																																																														
>4-20	±0.1																																																														
>20-50	±0.1																																																														
>50-100	±0.1																																																														
>100	±0.1																																																														
角度尺寸	±2°																																																														
设计																																																															
审核																																																															
批准																																																															
生效时间																																																															
名称		型号:																																																													
BH18650-1001		料号:																																																													
电池盒		模具编号	单位: MM 比例: 1:1																																																												
		版本: A1	视角: ② ③																																																												
		第 1 页 共 1 页																																																													
乐清市康尔电子有限公司 YUBATING WATER ELECTRON CO., LTD																																																															

(<https://www.chinadaier.com/wp-content/uploads/2017/07/BH18650-1001.jpg>)





YueQing Daier Electron Co.,Ltd

We have the most advanced real-time production capabilities in the industry, allowing us to quickly and cost-effectively provide customized products to solve unique and challenging applications.

## Company Profile

COMPANY PROFILE (<https://www.chinadaier.com/company-profile/>)

Certifications (<https://www.chinadaier.com/company-profile/certifications/>)

Team & Laboratory (<https://www.chinadaier.com/company-profile/quality-systems/>)

We're offline  
Leave a message



## Industry

MARINE TOGGLE AND ROCKER SWITCH & PANEL (<https://www.chinadaier.com/marine-switch-panel-toggle-and-rocker/>)

Automotive Switch And Parts (<https://www.chinadaier.com/automotive-switch-and-parts/>)

Musical Instrument (<https://www.chinadaier.com/musical-instrument-guitar-pedal-parts/>)

Household Appliances (<https://www.chinadaier.com/household-appliances/>)

Equipment Manufacturing (<https://www.chinadaier.com/equipment-manufacturing/>)

More Industries (<https://www.chinadaier.com/more-industries/>)

## Contact Us

 +0086-17706664353 (tel:+0086-17706664353)

 [sales1@chinadaier.com](mailto:sales1@chinadaier.com) (mailto:sales1@chinadaier.com)

 facebook (<https://www.facebook.com/profile.php?id=100076000044888>)

 youtube ([https://www.youtube.com/channel/UC6VmCUZbCt3hHI3\\_fXWa3Hw/videos](https://www.youtube.com/channel/UC6VmCUZbCt3hHI3_fXWa3Hw/videos))

 twitter

Copyright © 2022 DAIER All Rights Reserved.

We're offline  
Leave a message

