

2N5190G, 2N5191G, 2N5192G

Silicon NPN Power Transistors

Silicon NPN power transistors are for use in power amplifier and switching circuits – excellent safe area limits. Complement to PNP 2N5194, 2N5195.

Features

- Epoxy Meets UL 94 V-0 @ 0.125 in.
- These Devices are Pb-Free and are RoHS Compliant*

MAXIMUM RATINGS

Rating	Symbol	Value	Unit
Collector–Emitter Voltage 2N5190G 2N5191G 2N5192G	V_{CE0}	40 60 80	Vdc
Collector–Base Voltage 2N5190G 2N5191G 2N5192G	V_{CBO}	40 60 80	Vdc
Emitter–Base Voltage	V_{EBO}	5.0	Vdc
Collector Current	I_C	4.0	Adc
Base Current	I_B	1.0	Adc
Total Device Dissipation @ $T_C = 25^\circ\text{C}$ Derate above 25°C	P_D	40 320	W mW/ $^\circ\text{C}$
Operating and Storage Junction Temperature Range	T_J, T_{stg}	-65 to +150	$^\circ\text{C}$
ESD – Human Body Model	HBM	3B	V
ESD – Machine Model	MM	C	V

Stresses exceeding those listed in the Maximum Ratings table may damage the device. If any of these limits are exceeded, device functionality should not be assumed, damage may occur and reliability may be affected.

THERMAL CHARACTERISTICS

Characteristic	Symbol	Max	Unit
Thermal Resistance, Junction-to-Case	$R_{\theta JC}$	3.12	$^\circ\text{C}/\text{W}$

*For additional information on our Pb-Free strategy and soldering details, please download the ON Semiconductor Soldering and Mounting Techniques Reference Manual, SOLDERRM/D.



ON Semiconductor®

<http://onsemi.com>

**4.0 AMPERES
NPN SILICON
POWER TRANSISTORS
40, 60, 80 VOLTS – 40 WATTS**

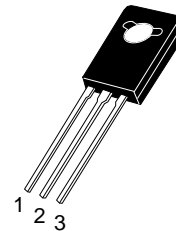
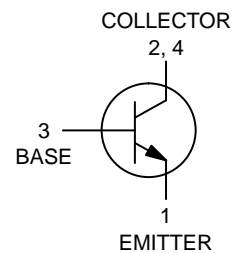

**TO-225
CASE 77-09
STYLE 1**

MARKING DIAGRAM

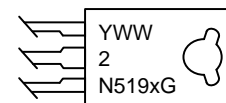

Y = Year
 WW = Work Week
 2N519x = Device Code
 x = 0, 1, or 2
 G = Pb-Free Package

ORDERING INFORMATION

Device	Package	Shipping
2N5190G	TO-225 (Pb-Free)	500 Units/Box
2N5191G	TO-225 (Pb-Free)	500 Units/Box
2N5192G	TO-225 (Pb-Free)	500 Units/Box

2N5190G, 2N5191G, 2N5192G

ELECTRICAL CHARACTERISTICS* ($T_C = 25^\circ\text{C}$ unless otherwise noted)

Characteristic	Symbol	Min	Max	Unit
OFF CHARACTERISTICS				
Collector–Emitter Sustaining Voltage (Note 1) ($I_C = 0.1\text{ Adc}$, $I_B = 0$) 2N5190G 2N5191G 2N5192G	$V_{CE(sus)}$	40 60 80	– – –	Vdc
Collector Cutoff Current ($V_{CE} = 40\text{ Vdc}$, $I_B = 0$) 2N5190G ($V_{CE} = 60\text{ Vdc}$, $I_B = 0$) 2N5191G ($V_{CE} = 80\text{ Vdc}$, $I_B = 0$) 2N5192G	I_{CEO}	– – –	1.0 1.0 1.0	mAdc
Collector Cutoff Current ($V_{CE} = 40\text{ Vdc}$, $V_{EB(off)} = 1.5\text{ Vdc}$) 2N5190G ($V_{CE} = 60\text{ Vdc}$, $V_{EB(off)} = 1.5\text{ Vdc}$) 2N5191G ($V_{CE} = 80\text{ Vdc}$, $V_{EB(off)} = 1.5\text{ Vdc}$) 2N5192G ($V_{CE} = 40\text{ Vdc}$, $V_{EB(off)} = 1.5\text{ Vdc}$, $T_C = 125^\circ\text{C}$) 2N5190G ($V_{CE} = 60\text{ Vdc}$, $V_{EB(off)} = 1.5\text{ Vdc}$, $T_C = 125^\circ\text{C}$) 2N5191G ($V_{CE} = 80\text{ Vdc}$, $V_{EB(off)} = 1.5\text{ Vdc}$, $T_C = 125^\circ\text{C}$) 2N5192G	I_{CEX}	– – – – – –	0.1 0.1 0.1 2.0 2.0 2.0	mAdc
Collector Cutoff Current ($V_{CB} = 40\text{ Vdc}$, $I_E = 0$) 2N5190G ($V_{CB} = 60\text{ Vdc}$, $I_E = 0$) 2N5191G ($V_{CB} = 80\text{ Vdc}$, $I_E = 0$) 2N5192G	I_{CBO}	– – –	0.1 0.1 0.1	mAdc
Emitter Cutoff Current ($V_{BE} = 5.0\text{ Vdc}$, $I_C = 0$)	I_{EBO}	–	1.0	mAdc
ON CHARACTERISTICS (Note 1)				
DC Current Gain ($I_C = 1.5\text{ Adc}$, $V_{CE} = 2.0\text{ Vdc}$) 2N5190G/2N5191G 2N5192G ($I_C = 4.0\text{ Adc}$, $V_{CE} = 2.0\text{ Vdc}$) 2N5190G/2N5191G 2N5192G	h_{FE}	25 20 10 7.0	100 80 – –	–
Collector–Emitter Saturation Voltage ($I_C = 1.5\text{ Adc}$, $I_B = 0.15\text{ Adc}$) ($I_C = 4.0\text{ Adc}$, $I_B = 1.0\text{ Adc}$)	$V_{CE(sat)}$	– –	0.6 1.4	Vdc
Base–Emitter On Voltage ($I_C = 1.5\text{ Adc}$, $V_{CE} = 2.0\text{ Vdc}$)	$V_{BE(on)}$	–	1.2	Vdc
DYNAMIC CHARACTERISTICS				
Current–Gain – Bandwidth Product ($I_C = 1.0\text{ Adc}$, $V_{CE} = 10\text{ Vdc}$, $f = 1.0\text{ MHz}$)	f_T	2.0	–	MHz

Product parametric performance is indicated in the Electrical Characteristics for the listed test conditions, unless otherwise noted. Product performance may not be indicated by the Electrical Characteristics if operated under different conditions.

*JEDEC Registered Data.

1. Pulse Test: Pulse Width $\leq 300\ \mu\text{s}$, Duty Cycle $\leq 2.0\%$.

2N5190G, 2N5191G, 2N5192G

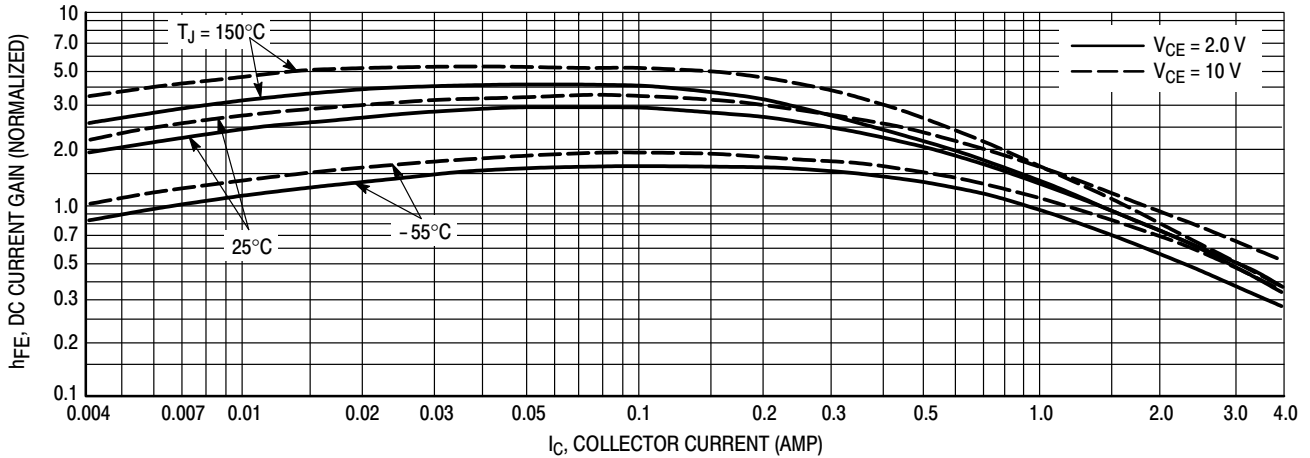

Figure 1. DC Current Gain

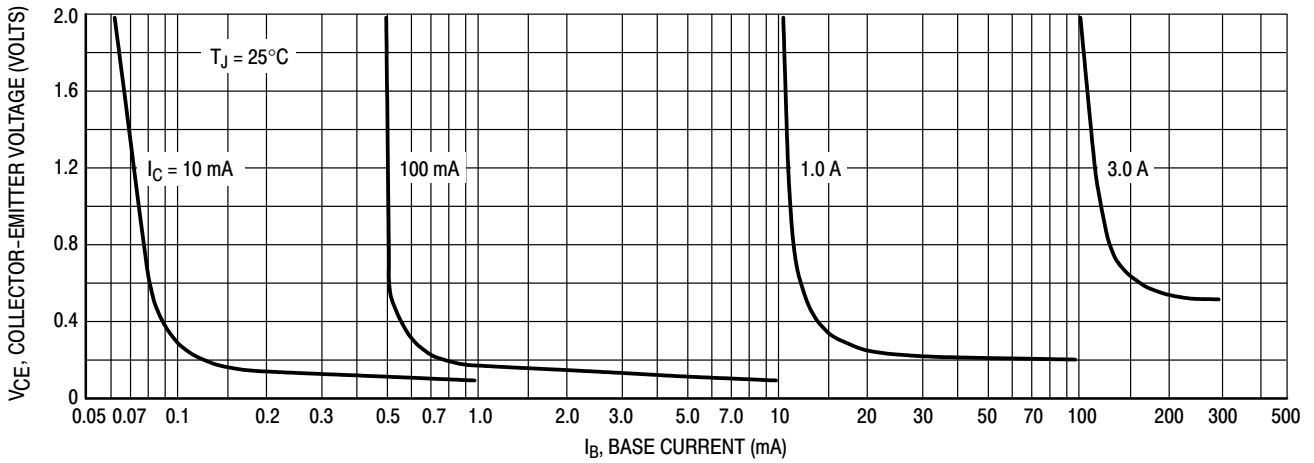

Figure 2. Collector Saturation Region

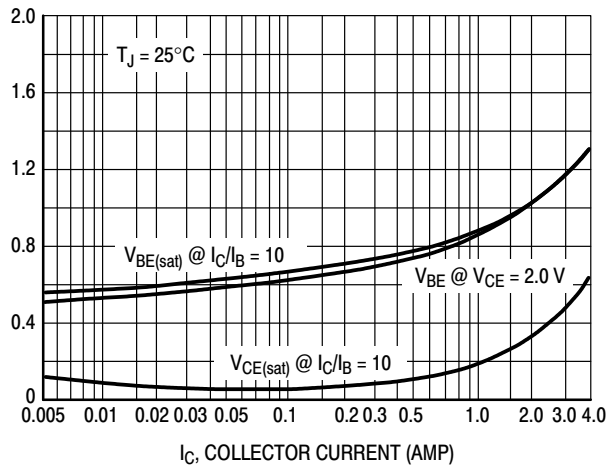

Figure 3. "On" Voltages

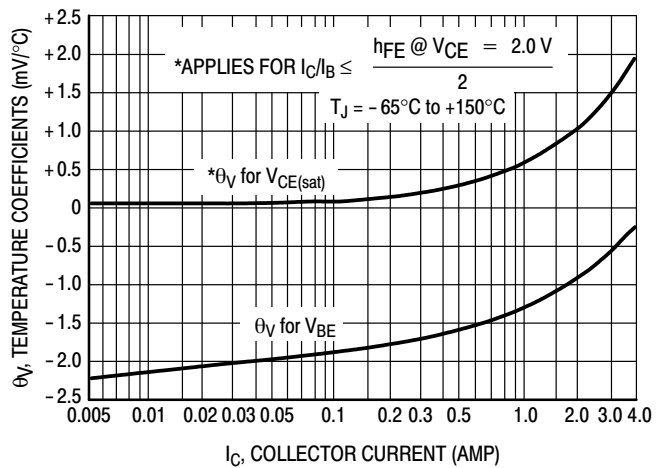

Figure 4. Temperature Coefficients

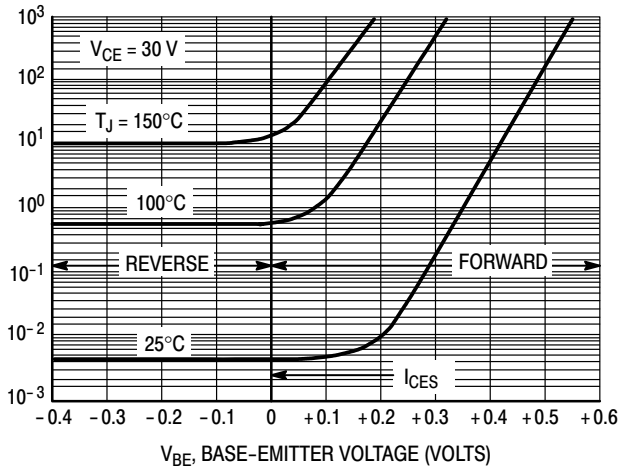

Figure 5. Collector Cut-Off Region

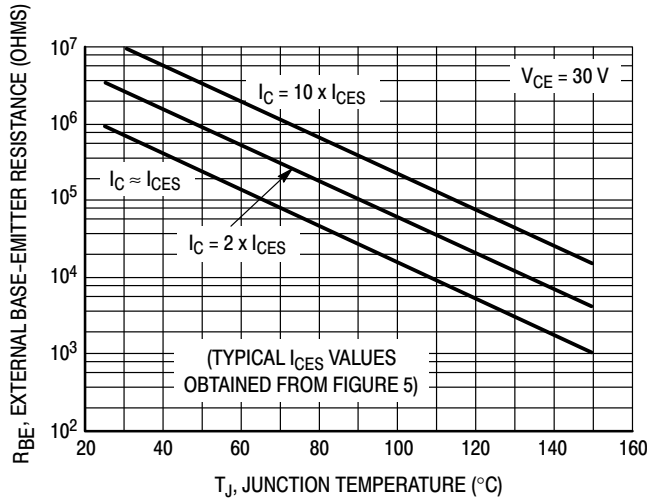

Figure 6. Effects of Base-Emitter Resistance

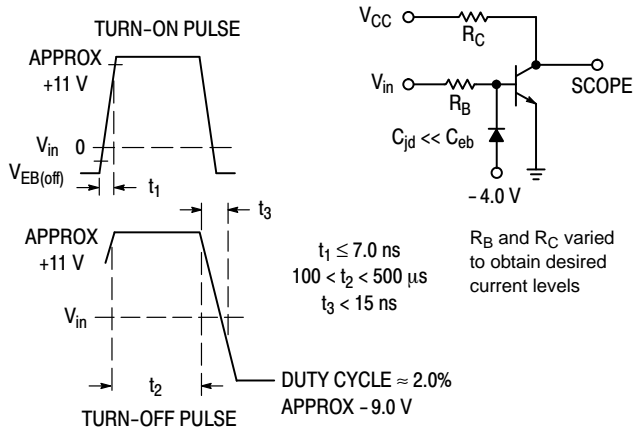

Figure 7. Switching Time Equivalent Test Circuit

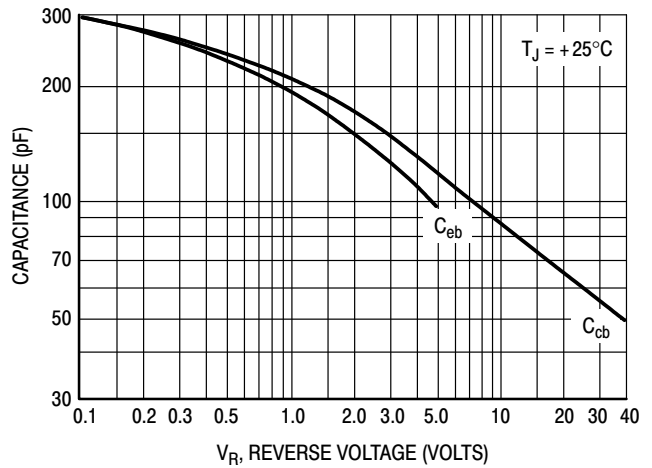

Figure 8. Capacitance

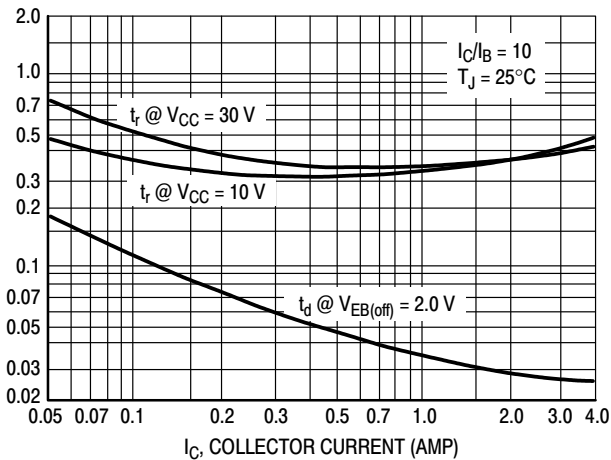

Figure 9. Turn-On Time

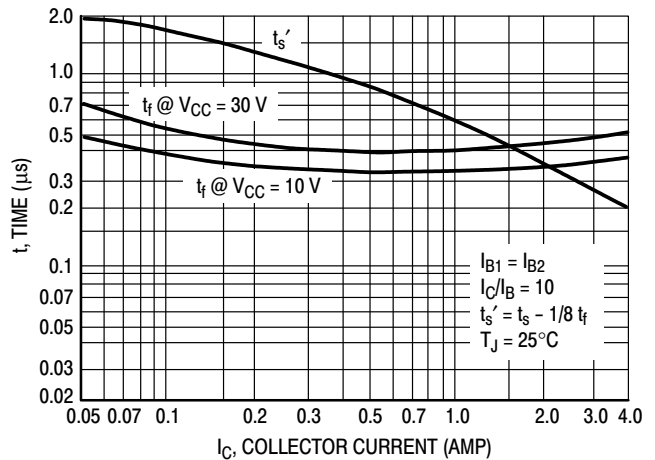
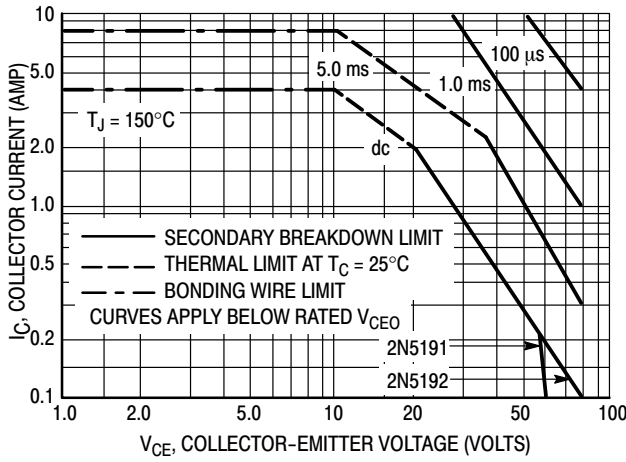

Figure 10. Turn-Off Time

2N5190G, 2N5191G, 2N5192G



**Figure 11. Rating and Thermal Data
Active-Region Safe Operating Area**

There are two limitations on the power handling ability of a transistor; average junction temperature and second breakdown. Safe operating area curves indicate $I_C - V_{CE}$ limits of the transistor that must be observed for reliable operation; i.e., the transistor must not be subjected to greater dissipation than the curves indicate.

The data of Figure 11 is based on $T_{J(pk)} = 150^\circ\text{C}$; T_C is variable depending on conditions. Second breakdown pulse limits are valid for duty cycles to 10% provided $T_{J(pk)} \leq 150^\circ\text{C}$. At high case temperatures, thermal limitations will reduce the power that can be handled to values less than the limitations imposed by second breakdown.

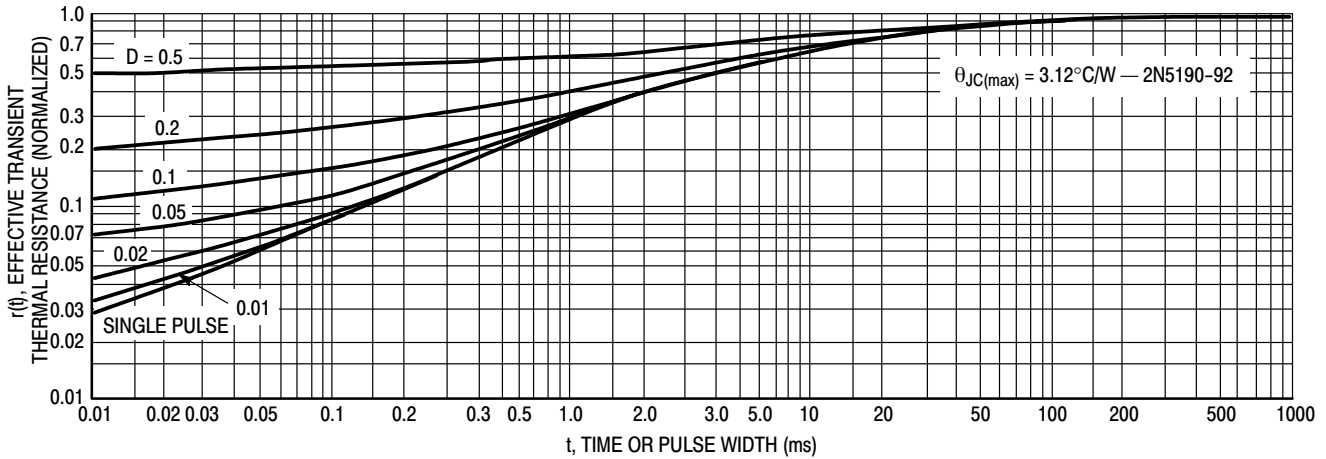

Figure 12. Thermal Response

DESIGN NOTE: USE OF TRANSIENT THERMAL RESISTANCE DATA

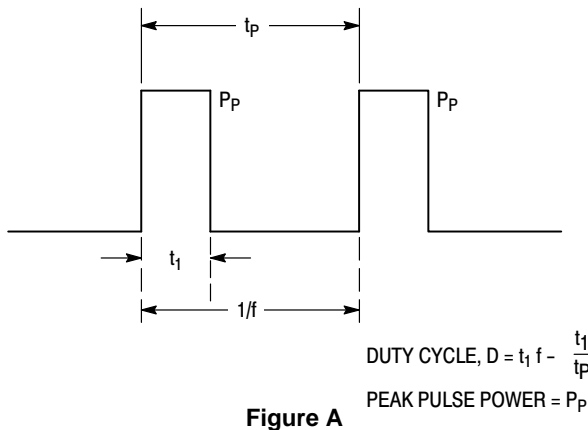

Figure A

A train of periodical power pulses can be represented by the model shown in Figure A. Using the model and the device thermal response, the normalized effective transient thermal resistance of Figure 12 was calculated for various duty cycles.

To find $\theta_{JC}(t)$, multiply the value obtained from Figure 12 by the steady state value θ_{JC} .

Example:

The 2N5190 is dissipating 50 watts under the following conditions: $t_1 = 0.1$ ms, $t_p = 0.5$ ms. ($D = 0.2$).

Using Figure 12, at a pulse width of 0.1 ms and $D = 0.2$, the reading of $r(t_1, D)$ is 0.27.

The peak rise in function temperature is therefore:

$$\Delta T = r(t) \times P_p \times \theta_{JC} = 0.27 \times 50 \times 3.12 = 42.2^\circ\text{C}$$

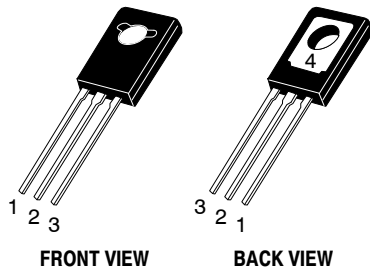

TO-225
CASE 77-09
ISSUE AD

DATE 25 MAR 2015

SCALE 1:1

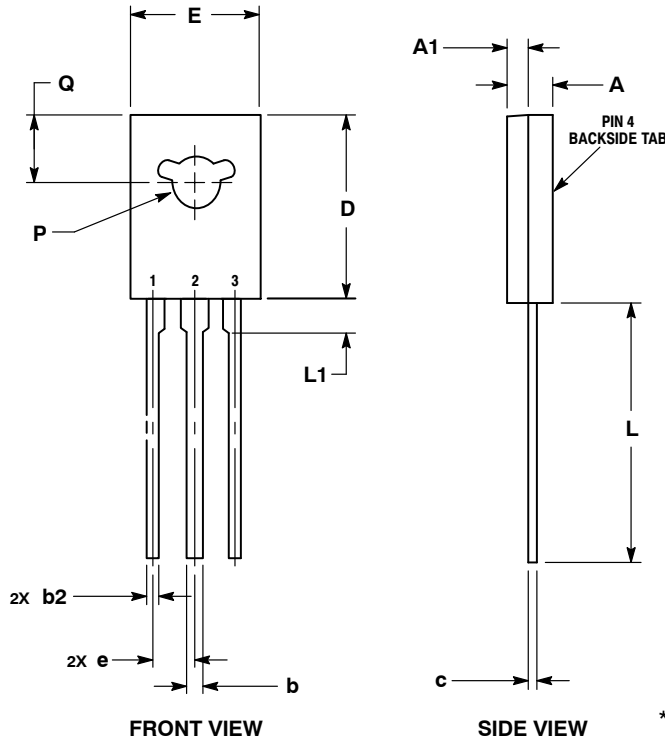

NOTES:

1. DIMENSIONING AND TOLERANCING PER ASME Y14.5M, 1994.
2. CONTROLLING DIMENSION: MILLIMETERS.
3. NUMBER AND SHAPE OF LUGS OPTIONAL.

MILLIMETERS		
DIM	MIN	MAX
A	2.40	3.00
A1	1.00	1.50
b	0.60	0.90
b2	0.51	0.88
c	0.39	0.63
D	10.60	11.10
E	7.40	7.80
e	2.04	2.54
L	14.50	16.63
L1	1.27	2.54
P	2.90	3.30
Q	3.80	4.20

GENERIC MARKING DIAGRAM*

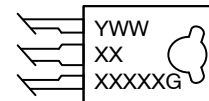

- Y = Year
- WW = Work Week
- XXXXX = Device Code
- G = Pb-Free Package

*This information is generic. Please refer to device data sheet for actual part marking. Pb-Free indicator, "G" or microdot "μ", may or may not be present. Some products may not follow the Generic Marking.

STYLE 1: PIN 1. EMITTER 2., 4. COLLECTOR 3. BASE	STYLE 2: PIN 1. CATHODE 2., 4. ANODE 3. GATE	STYLE 3: PIN 1. BASE 2., 4. COLLECTOR 3. EMITTER	STYLE 4: PIN 1. ANODE 1 2., 4. ANODE 2 3. GATE	STYLE 5: PIN 1. MT 1 2., 4. MT 2 3. GATE
STYLE 6: PIN 1. CATHODE 2., 4. GATE 3. ANODE	STYLE 7: PIN 1. MT 1 2., 4. GATE 3. MT 2	STYLE 8: PIN 1. SOURCE 2., 4. GATE 3. DRAIN	STYLE 9: PIN 1. GATE 2., 4. DRAIN 3. SOURCE	STYLE 10: PIN 1. SOURCE 2., 4. DRAIN 3. GATE

DOCUMENT NUMBER:	98ASB42049B	Electronic versions are uncontrolled except when accessed directly from the Document Repository. Printed versions are uncontrolled except when stamped "CONTROLLED COPY" in red.
DESCRIPTION:	TO-225	PAGE 1 OF 1

onsemi and ONsemi are trademarks of Semiconductor Components Industries, LLC dba onsemi or its subsidiaries in the United States and/or other countries. onsemi reserves the right to make changes without further notice to any products herein. onsemi makes no warranty, representation or guarantee regarding the suitability of its products for any particular purpose, nor does onsemi assume any liability arising out of the application or use of any product or circuit, and specifically disclaims any and all liability, including without limitation special, consequential or incidental damages. onsemi does not convey any license under its patent rights nor the rights of others.

onsemi, **Onsemi**, and other names, marks, and brands are registered and/or common law trademarks of Semiconductor Components Industries, LLC dba "**onsemi**" or its affiliates and/or subsidiaries in the United States and/or other countries. **onsemi** owns the rights to a number of patents, trademarks, copyrights, trade secrets, and other intellectual property. A listing of **onsemi**'s product/patent coverage may be accessed at www.onsemi.com/site/pdf/Patent-Marking.pdf. **onsemi** reserves the right to make changes at any time to any products or information herein, without notice. The information herein is provided "as-is" and **onsemi** makes no warranty, representation or guarantee regarding the accuracy of the information, product features, availability, functionality, or suitability of its products for any particular purpose, nor does **onsemi** assume any liability arising out of the application or use of any product or circuit, and specifically disclaims any and all liability, including without limitation special, consequential or incidental damages. Buyer is responsible for its products and applications using **onsemi** products, including compliance with all laws, regulations and safety requirements or standards, regardless of any support or applications information provided by **onsemi**. "Typical" parameters which may be provided in **onsemi** data sheets and/or specifications can and do vary in different applications and actual performance may vary over time. All operating parameters, including "Typicals" must be validated for each customer application by customer's technical experts. **onsemi** does not convey any license under any of its intellectual property rights nor the rights of others. **onsemi** products are not designed, intended, or authorized for use as a critical component in life support systems or any FDA Class 3 medical devices or medical devices with a same or similar classification in a foreign jurisdiction or any devices intended for implantation in the human body. Should Buyer purchase or use **onsemi** products for any such unintended or unauthorized application, Buyer shall indemnify and hold **onsemi** and its officers, employees, subsidiaries, affiliates, and distributors harmless against all claims, costs, damages, and expenses, and reasonable attorney fees arising out of, directly or indirectly, any claim of personal injury or death associated with such unintended or unauthorized use, even if such claim alleges that **onsemi** was negligent regarding the design or manufacture of the part. **onsemi** is an Equal Opportunity/Affirmative Action Employer. This literature is subject to all applicable copyright laws and is not for resale in any manner.

ADDITIONAL INFORMATION

TECHNICAL PUBLICATIONS:

Technical Library: www.onsemi.com/design/resources/technical-documentation
onsemi Website: www.onsemi.com

ONLINE SUPPORT: www.onsemi.com/support

For additional information, please contact your local Sales Representative at www.onsemi.com/support/sales