

Voltage Regulation

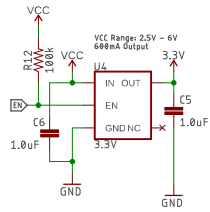

Jumpers

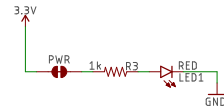
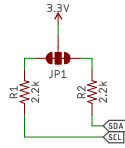

Humidity and Temperature: SHTC3

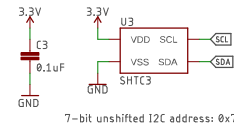

7-bit unshifted I2C address: 0x70

CO2 Sensor: STC31

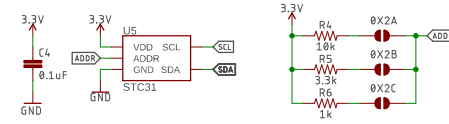

Default 7-bit unshifted I2C address: 0x29
Close a split pad to select an alternate address

Function Connector

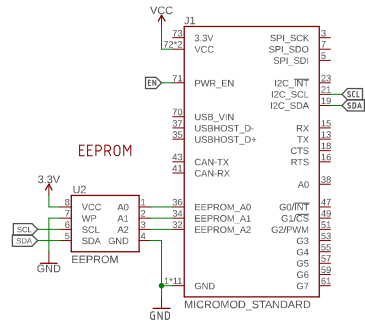

Air Quality Sensor: SGP40

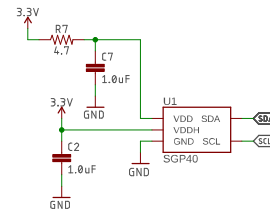

Abs min/max Vdd and Vddh: -0.3 to +3.6V
Operating current @ 3.3V: 3.0 mA
7-bit unshifted I2C address: 0x59



Released under the Creative Commons Attribution Share-Alike 4.0 License
<https://creativecommons.org/licenses/by-sa/4.0/>

TITLE: MicroMod_Environmental

Design by: Elias Santistevan

REV:
v10

Date: 10/22/2021 5:37 PM

Sheet: 1/1