

RTC Backup

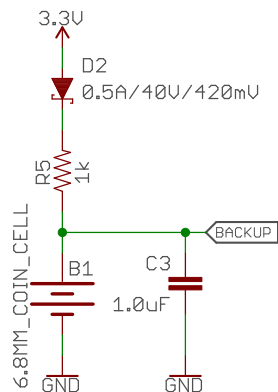

Ublox NEO-M8P

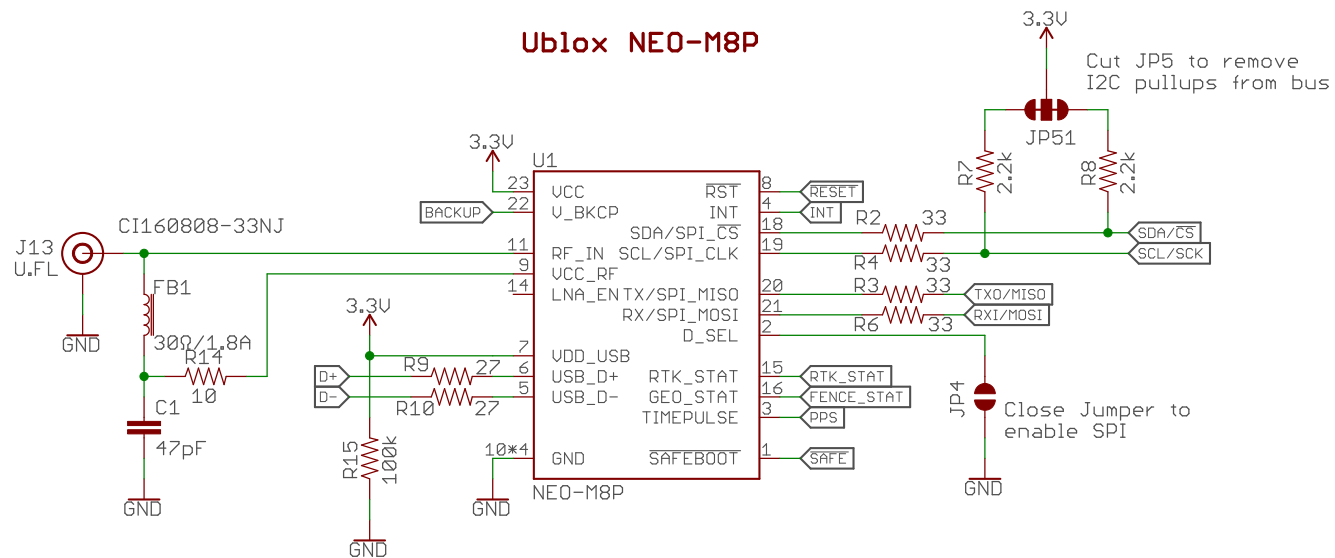

7-bit unshifted I2C address: 0x42

Stat LEDs

Cut jumper to disable PPS LED

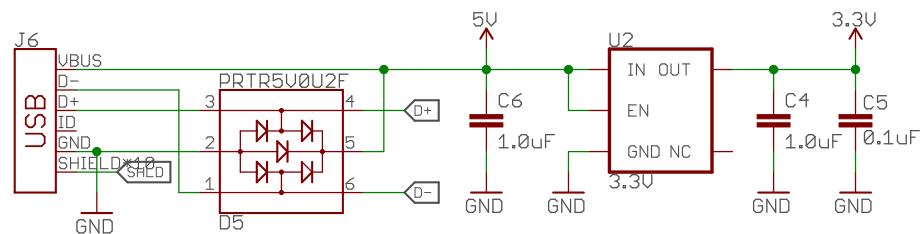
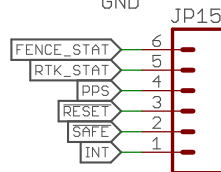
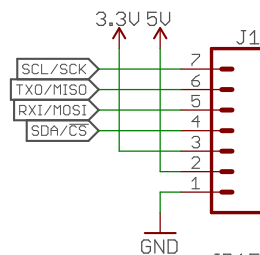
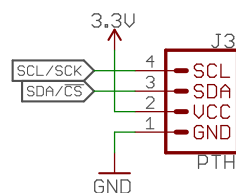
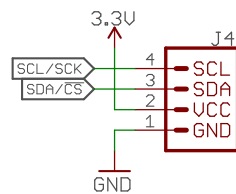
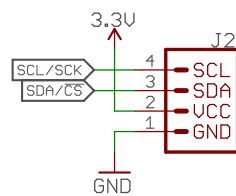
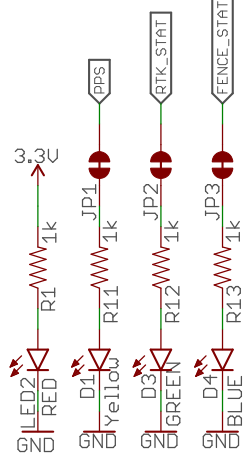

SPARK X

open hardware

Released under the Creative Commons Attribution Share-Alike 4.0 License
<https://creativecommons.org/licenses/by-sa/4.0/>

TITLE: Qwiic GPS-RTK - ublox NEO-M8P

Design by:

REV:
V10

Date: 9/6/2018 3:08 PM

Sheet: 1/1