



600W Single Output with PFC Function

HRP-600N series



AS/NZS 62368.1



UL62368-1



EN62368-1



TPTC004



IEC62368-1



Automate



Industrial



Network



Telecom



Security

■ Features

- Universal AC input / Full range
- Built-in active PFC function, PF>0.94
- 200% peak power capability
- High efficiency up to 89%
- Withstand 300VAC surge input for 5 seconds
- Protections: Short circuit / Overload / Over voltage / Over temperature
- Built-in cooling fan ON-OFF control
- Built-in DC OK signal
- Built-in remote sense function
- 5 years warranty

■ Applications

- Industrial automation machinery
- Industrial control system
- Mechanical and electrical equipment
- Diagnostic or biological facilities
- Test or measurement systems
- Telecommunication equipment

■ Description

HRP-600N is a 600W single output type AC/DC power supply. This series operates for 85~264VAC input voltage and offers the models with the DC output mostly demanded from the industry. Each model is cooled by the built-in fan with fan ON-OFF control, working for the temperature up to 70°C. Moreover, HRP-600N provides 200% short-duration peak power for motor applications and electromechanical loads requiring much higher power during start-up.

■ Model Encoding

HRP - 600N - 24

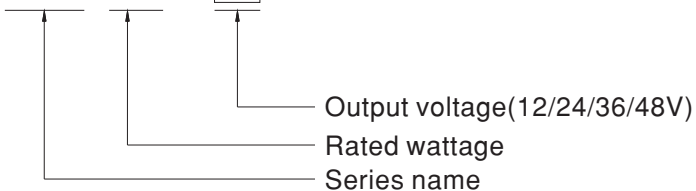



SPECIFICATION

MODEL		HRP-600N-12	HRP-600N-24	HRP-600N-36	HRP-600N-48	
OUTPUT	DC VOLTAGE	12V	24V	36V	48V	
	RATED CURRENT	53A	27A	17.5A	13A	
	CURRENT RANGE	0 ~ 53A	0 ~ 27A	0 ~ 17.5A	0 ~ 13A	
	RATED POWER	636W	648W	630W	624W	
	RIPPLE & NOISE (max.) Note.2	200mVp-p	150mVp-p	200mVp-p	240mVp-p	
	VOLTAGE ADJ. RANGE	10.2 ~ 13.8V	21.6 ~ 28.8V	28.8 ~ 39.6V	40.8 ~ 55.2V	
	VOLTAGE TOLERANCE Note.3	± 1.0%	± 1.0%	± 1.0%	± 1.0%	
	LINE REGULATION	± 0.3%	± 0.2%	± 0.2%	± 0.2%	
	LOAD REGULATION	± 0.5%	± 0.5%	± 0.5%	± 0.5%	
	SETUP, RISE TIME	1800ms, 50ms/230VAC 3600ms, 50ms/115VAC at full load				
HOLD UP TIME (Typ.)	16ms/230VAC 16ms/115VAC at full load					
INPUT	VOLTAGE RANGE Note.4	85 ~ 264VAC 120 ~ 370VDC				
	FREQUENCY RANGE	47 ~ 63Hz				
	POWER FACTOR (Typ.)	PF>0.94/230VAC PF>0.98/115VAC at full load				
	EFFICIENCY (Typ.)	88%	88%	89%	89%	
	AC CURRENT (Typ.)	7.6A/115VAC 3.6A/230VAC				
	INRUSH CURRENT (Typ.)	35A/115VAC 70A/230VAC				
LEAKAGE CURRENT	<1.5mA / 240VAC					
PROTECTION	OVERLOAD	Normally works within 105 ~ 200% rated output power for more than 5 seconds and then shut down o/p voltage, re-power on to recover Constant current limiting for output power >220% rated for more than 5 seconds and then shut down o/p voltage, re-power on to recover				
	OVER VOLTAGE	14.4 ~ 16.8V	30 ~ 34.8V	41.4 ~ 48.6V	57.6 ~ 67.2V	
	OVER TEMPERATURE	Shut down o/p voltage, recovers automatically after temperature goes down Protection type : Shut down o/p voltage, re-power on to recover				
FUNCTION	DC OK SIGNAL	PSU turn on : 3.3 ~ 5.6V ; PSU turn off : 0 ~ 1V				
	FAN CONTROL (Typ.)	Load 35 ± 15% or RTH2 ≥ 50°C Fan on				
ENVIRONMENT	WORKING TEMP.	-40 ~ +70°C (Refer to "Derating Curve")				
	WORKING HUMIDITY	20 ~ 90% RH non-condensing				
	STORAGE TEMP., HUMIDITY	-40 ~ +85°C, 10 ~ 95% RH non-condensing				
	TEMP. COEFFICIENT	± 0.03%/°C (0 ~ 50°C)				
	VIBRATION	10 ~ 500Hz, 5G 10min./1cycle, 60min. each along X, Y, Z axes				
	OPERATING ALTITUDE Note.6	5000 meters				
SAFETY & EMC (Note 5)	SAFETY STANDARDS	UL62368-1, TUV EN62368-1, EAC TP TC 004, AS/NZS 62368.1 approved				
	WITHSTAND VOLTAGE	I/P-O/P:3KVAC I/P-FG:2KVAC O/P-FG:0.5KVAC				
	ISOLATION RESISTANCE	I/P-O/P, I/P-FG, O/P-FG:100M Ohms / 500VDC / 25°C / 70% RH				
	EMC EMISSION	Parameter	Standard		Test Level / Note	
		Conducted	EN55032		Class B	
		Radiated	EN55032		Class B	
		Harmonic current	EN61000-3-2		Class A	
		Voltage Flicker	EN61000-3-3		-----	
	EMC IMMUNITY	EN55035 , EN61000-6-2(EN50082-2)				
		Parameter	Standard		Test Level / Note	
		ESD	EN61000-4-2		Level 3, 8KV air; Level 2, 4KV contact	
		RF field	EN61000-4-3		Level 3, 10V/m	
		EFT/ Burst	EN61000-4-4		Level 3, 2KV	
		Surge	EN61000-4-5		Level 4, 4KV/Line-FG; 2KV/Line-Line	
Conducted		EN61000-4-6		Level 3, 10V		
Magnetic Field		EN61000-4-8		Level 4, 30A/m		
Voltage Dips and Interruptions	EN61000-4-11		95% dip 0.5 periods, 30% dip 25 periods, 95% interruptions 250 periods			
OTHERS	MTBF	452.04K hrs min. Telcordia TR/SR-332 (Bellcore) ; 191.26K hrs min. MIL-HDBK-217F (25°C)				
	DIMENSION	218*105*61.5mm (L*W*H)				
	PACKING	1.39Kg;8pcs/12.1Kg/1.58CUFT				
NOTE	<p>1. All parameters NOT specially mentioned are measured at 230VAC input, rated load and 25°C of ambient temperature. 2. Ripple & noise are measured at 20MHz of bandwidth by using a 12" twisted pair-wire terminated with a 0.1uf & 47uf parallel capacitor. 3. Tolerance : includes set up tolerance, line regulation and load regulation. 4. Derating may be needed under low input voltages. Please check the derating curve for more details. 5. The power supply is considered a component which will be installed into a final equipment. All the EMC tests are been executed by mounting the unit on a 360mm*360mm metal plate with 1mm of thickness. The final equipment must be re-confirmed that it still meets EMC directives. For guidance on how to perform these EMC tests, please refer to "EMI testing of component power supplies." (as available on http://www.meanwell.com) 6. The ambient temperature derating of 3.5°C/1000m with fanless models and of 5°C/1000m with fan models for operating altitude higher than 2000m(6500ft). ※ Product Liability Disclaimer : For detailed information, please refer to https://www.meanwell.com/serviceDisclaimer.aspx</p>					

Block Diagram

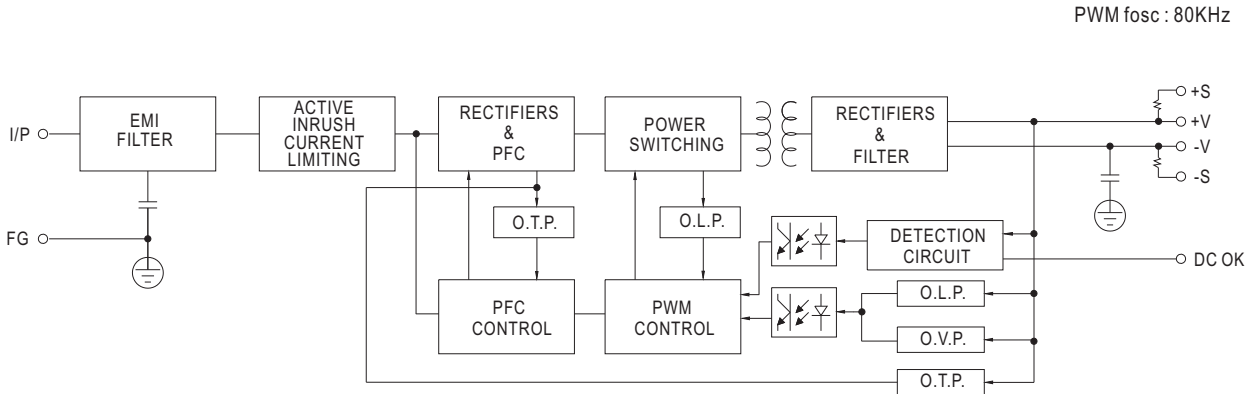

Derating Curve

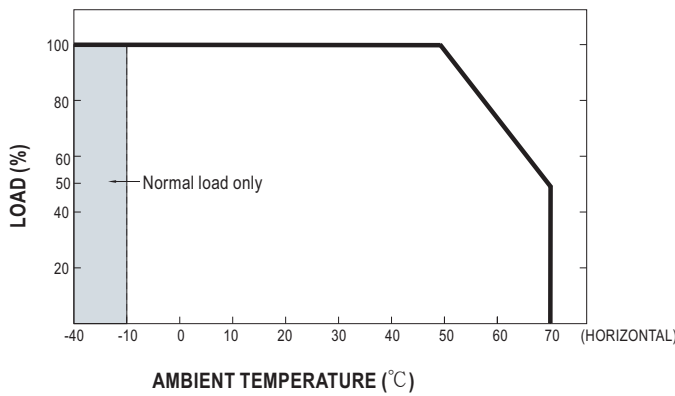

Output Derating VS Input Voltage

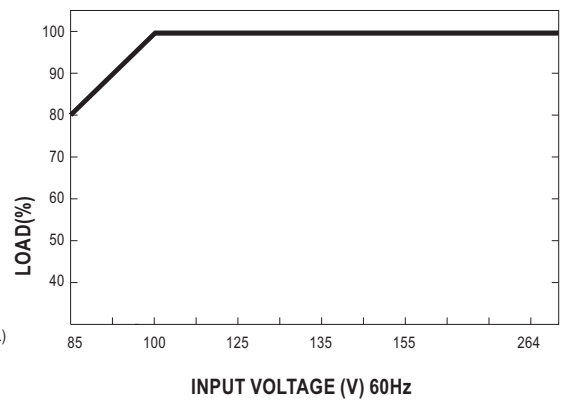

Function Manual

1. Remote Sense

The remote sensing compensates voltage drop on the load wiring up to 0.5V.

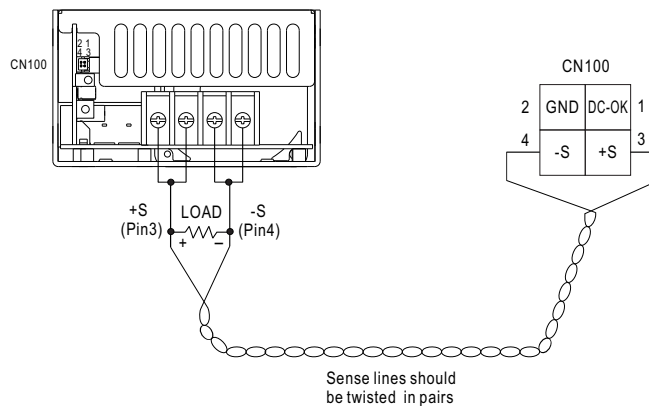

Fig 1.1

2. DC-OK Signal

DC-OK signal is a TTL level signal. High when PSU turns on.

Between DC-OK(pin3) and GND(pin5)	Output Status
3.3 ~ 5.6V	ON
0 ~ 1V	OFF

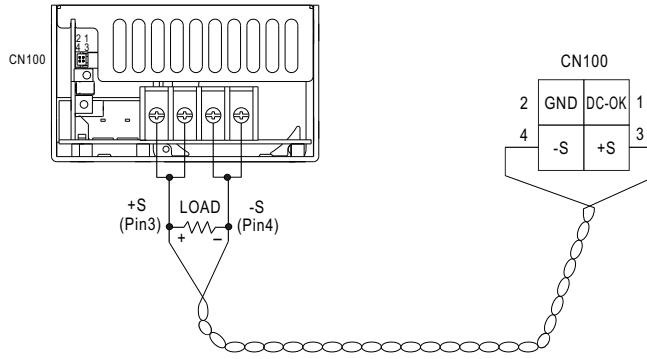

Fig 2.1

Sense lines should be twisted in pairs

3. Peak Power

$$P_{av} = \frac{P_{pk} \times t + P_{npk} \times (T-t)}{T} \leq P_{rated}$$

$$\text{Duty} \frac{t}{T} \times 100\% \leq 35\%$$

$$t \leq 5 \text{ sec}$$

P_{av} : Average output power (W)

P_{pk} : Peak output power (W)

P_{npk} : Non-peak output power (W)

P_{rated} : Rated output power (W)

t : Peak power width (sec)

T : Period (sec)

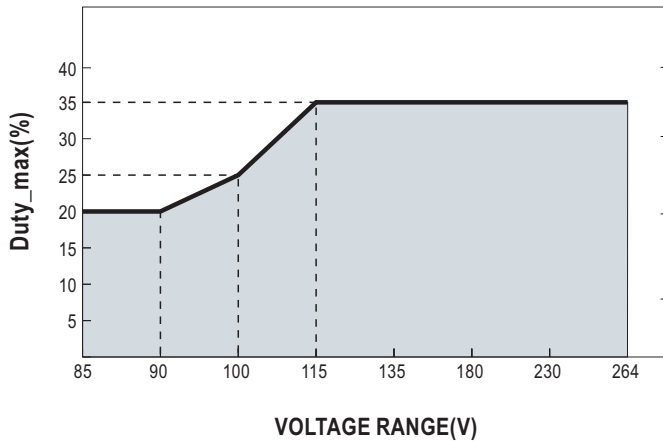
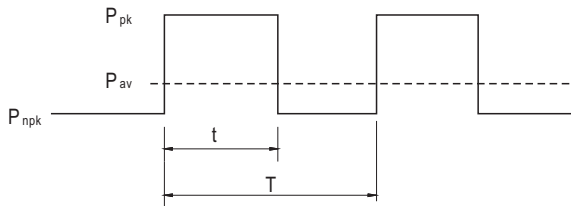

For example (12V model) :

$V_{in} = 100V$ $\text{Duty}_{max} = 25\%$

$P_{av} = P_{rated} = 636W$

$P_{pk} = 200\% P_{rated} = 1272W$

$t \leq 5 \text{ sec}$

$T \geq 20 \text{ sec}$

$$P_{av} = \frac{P_{pk} \times t + P_{npk} \times (T-t)}{T} = \frac{1272 \times 5 + P_{npk} (20-5)}{20} \leq 636W$$

$$P_{npk} \leq 424W$$

Mechanical Specification

Case No. 977A Unit:mm

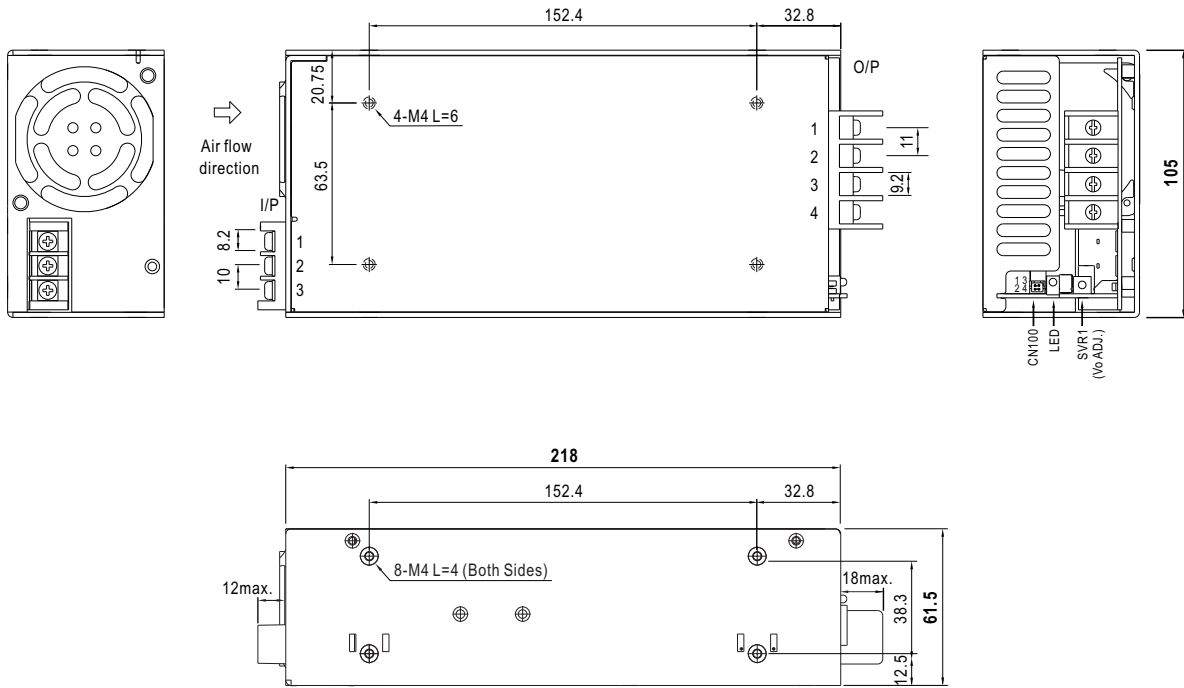

AC Input Terminal Pin No. Assignment

Pin No.	Assignment
1	AC/L
2	AC/N
3	FG \perp

DC Output Terminal Pin No. Assignment

Pin No.	Assignment
1~2	-V
3~4	+V

Connector Pin No. Assignment(CN100) : HRS DF11-4DP-2DS or equivalent

Pin No.	Assignment	Mating Housing	Terminal
1	DC-OK	HRS DF11-4DS or equivalent	HRS DF11-**SC or equivalent
2	GND		
3	+S		
4	-S		

Installation Manual

Please refer to : <http://www.meanwell.com/manual.html>