

Microstrip Calculations  
 Copper Thickness (1oz± 1.4mil) 0.035mm  
 Board thickness: 1.6mm  
 Dielectric thickness (Layer 1 to 2): 0.2mm  
 Eri 4.4  
 Polygon Isolations 6mil/0.1524mm  
 RF Trace Width: 13mil/0.33mm  
<https://chemandy.com/calculators/calculator-usb-impedance-calculator.htm>

### u-blox ZED-F9P

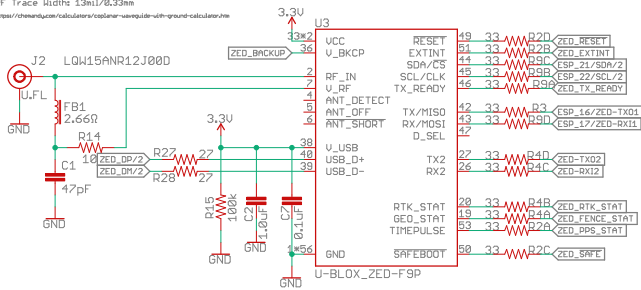

7-bit unshifted I2C address: 0x42

### Data Output Selection

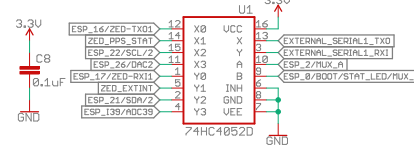

### LiPo Charger @ 1A

Use with >1Ah 3.7V Battery

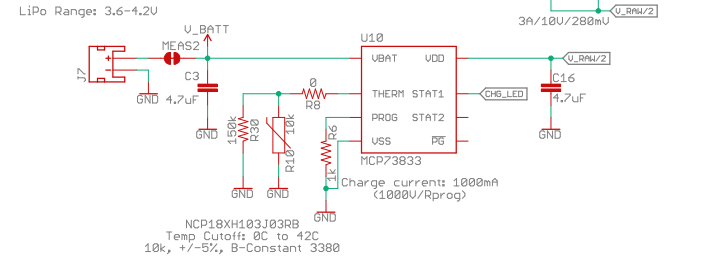

### Fuel Gauge

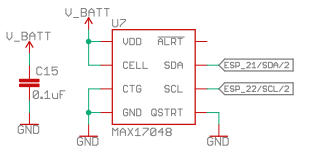

### Connections

#### From Connectors Board

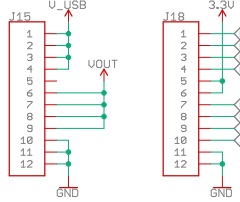

#### From Display Board

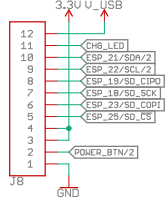

### USB-to-Serial For ESP32

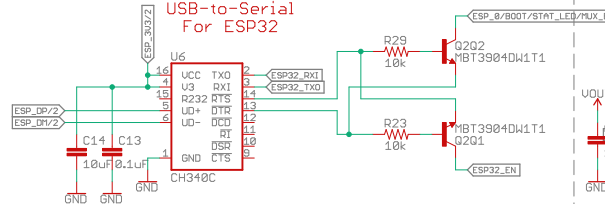

### Peripheral 3.3V

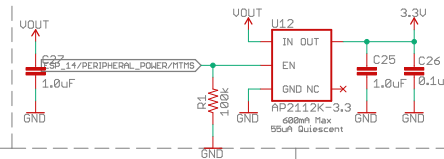

### RTC Backup

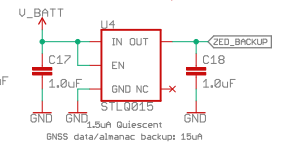

#### From Radio Board

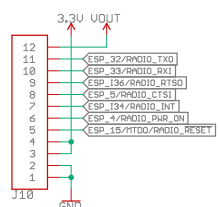

### ESP32-WROOM

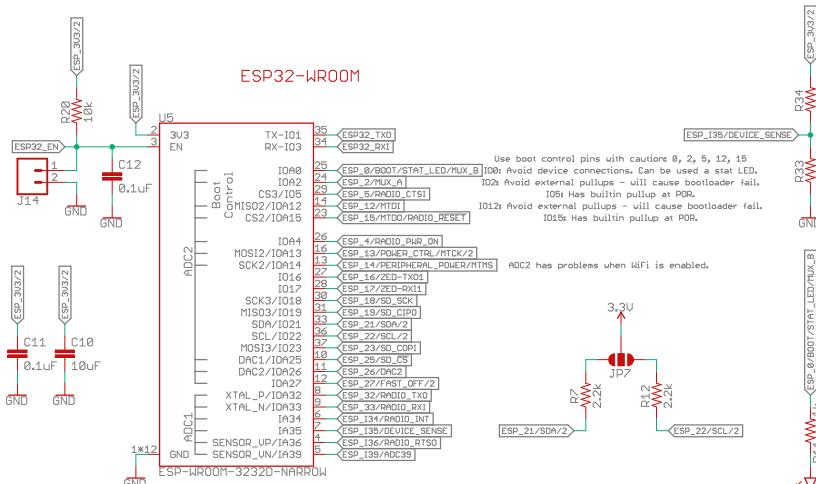

Released under the Creative Commons Attribution Share-Alike 4.0 License  
<https://creativecommons.org/licenses/by-sa/4.0/>

TITLE: SparkFun RTK Facet - Main  
 Design by: N. Seidle  
 Date: 12/3/2021 11:52 AM  
 Sheet: 1/2

Special Instructions  
 No clean process

REV: v12

### Soft Power Switch

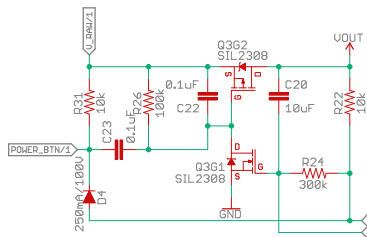

Power Button on Membrane Overlay

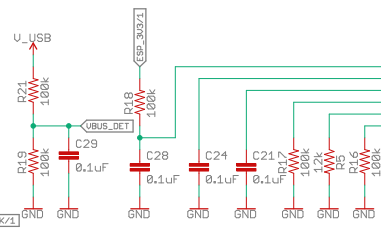

### USB Hub

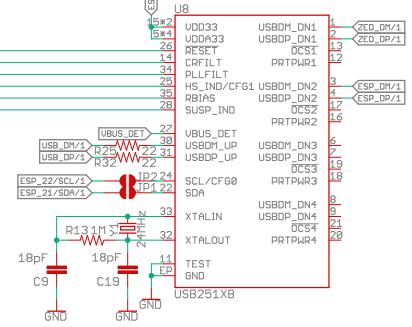

7-bit unshifted I2C address: 0x2C  
 Any USB2512, USB2513, or USB2514 can be used

Released under the Creative Commons Attribution Share-Alike 4.0 License <a href="https://creativecommons.org/licenses/by-sa/4.0/">https://creativecommons.org/licenses/by-sa/4.0/</a>	
TITLE: SparkFun RTK Facet - Main	
Design by:	REV:
Date: 12/3/2021 11:52 AM	Sheet: 2/2