

1Wire Bus

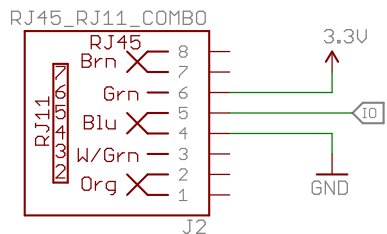

1WIRE PTH

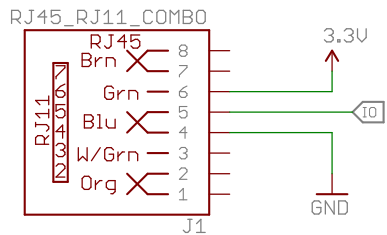
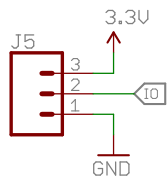

Qwiic I2C ports

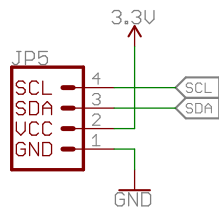
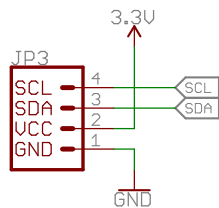

I2C PTH

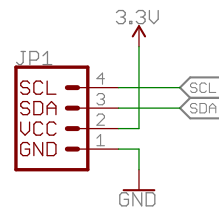

DS28E17

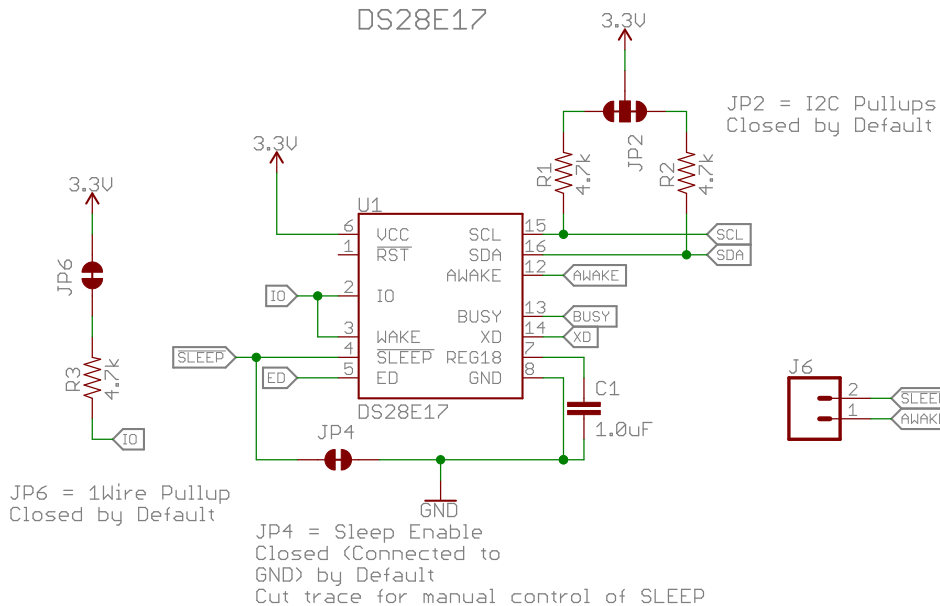

SPARK X



open hardware



Released under the Creative Commons Attribution Share-Alike 4.0 License
<https://creativecommons.org/licenses/by-sa/4.0/>

TITLE: Qwiic_1Wire_to_I2C_Bridge_DS28E17

Design by: Joel Bartlett

REV:
X10

Date: 4/20/17 11:26 AM

Sheet: 1/1