

AN48840B

Low current consumption, high sensitivity CMOS Hall IC
 Alternating magnetic field operation (For low-speed rotation detection)

Overview

The AN48840B is a Hall IC (a magnetic sensor) which has 2 times or more sensitivity and a low current consumption of about one fiftieth compared with our conventional one.

In this Hall IC, a Hall element, a offset cancel circuit, an amplifier circuit, a sample and hold circuit, a Schmidt circuit, and output stage FET are integrated on a single chip housed in a small package by IC technique.

Features

- High sensitivity (6 mT max.) due to offset cancel circuit and a new sample and hold circuit
- Small current by using intermittent action
 (Average supply current: 56 μ A typ., Sampling period: 670 μ s typ.)
- Small package (SMD)
- CMOS inverter output (logic output form)

Applications

- Functional operation key, Mouse,
 Appliances for low-speed rotation detection

Block Diagram

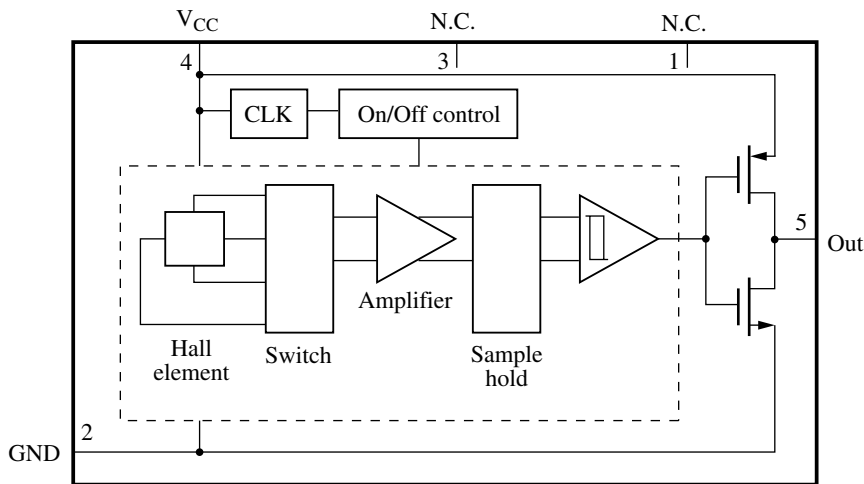

Pin Descriptions

Pin No.	Symbol	Description	Pin No.	Symbol	Description
1	N.C.	—	4	V _{CC}	Power supply
2	GND	Ground	5	Out	Output
3	N.C.	—			

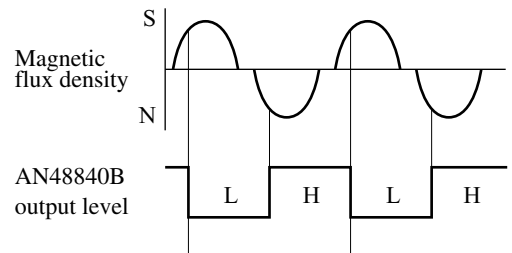
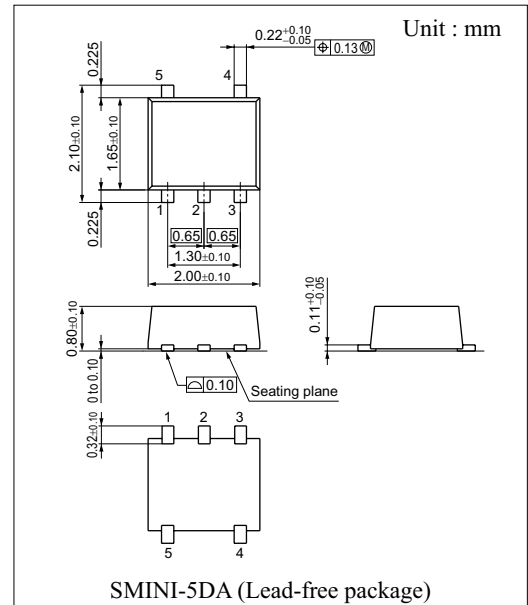

■ Absolute Maximum Ratings

Parameter	Symbol	Rating	Unit
Supply voltage	V_{CC}	5	V
Output voltage	V_{OUT}	5	V
Supply current	I_{CC}	5	mA
Output current	I_{OUT}	15	mA
Power dissipation *1,*2	P_D	60	mW
Operating ambient temperature *1	T_{opr}	-25 to +75	°C
Storage temperature *1	T_{stg}	-55 to +125	°C

Note) *1: Except for the power dissipation, operating ambient temperature and storage temperature, all ratings are for $T_a = 25^\circ\text{C}$.

*2: $T_a = 75^\circ\text{C}$. For the independent IC without a heat sink. Please use within the range of power dissipation, referring to $P_D - T_a$ curve.

■ Recommended Operating Range

Parameter	Symbol	Range	Unit
Supply voltage	V_{CC}	2.5 to 3.5	V

■ Electrical Characteristics $T_a = 25^\circ\text{C} \pm 2^\circ\text{C}$

Parameter	Symbol	Conditions	Min	Typ	Max	Unit
Operating magnetic flux density 1 *1	B_{HL}	$V_{CC} = 3\text{ V}, V_{CC} = 2.5\text{ V}$	0.5	—	6	mT
Operating magnetic flux density 2 *2	B_{LH}	$V_{CC} = 3\text{ V}, V_{CC} = 2.5\text{ V}$	-6	—	-0.5	mT
Output voltage 1	V_{OL1}	$V_{CC} = 3\text{ V}, I_O = 2\text{ mA}, B = 6.0\text{ mT}$	—	0.1	0.3	V
Output voltage 1	V_{OL2}	$V_{CC} = 2.5\text{ V}, I_O = 2\text{ mA}, B = 6.0\text{ mT}$	—	0.1	0.3	V
Output voltage 2	V_{OH1}	$V_{CC} = 3\text{ V}, I_O = -2\text{ mA}, B = -6.0\text{ mT}$	2.7	2.9	—	V
Output voltage 2	V_{OH2}	$V_{CC} = 2.5\text{ V}, I_O = -2\text{ mA}, B = -6.0\text{ mT}$	2.7	2.9	—	V
Supply current 1 *3	I_{CCAVE}	$V_{CC} = 3\text{ V}$	—	56.0	85.0	μA
Supply current 2 *3	I_{CC2AVE}	$V_{CC} = 2.5\text{ V}$	—	48.0	72.0	μA
Intermittent action time	T_{sam}	$V_{CC} = 3\text{ V}$	490	670	850	μS
Intermittent action time 2	T_{sam2}	$V_{CC} = 2.5\text{ V}$	513	710	890	μS

Note) *1: Symbol B_{H-LS} , B_{H-LN} stands for the operating magnetic flux density where its output level varies from high to low.

*2: Symbol B_{L-HS} , B_{L-HN} stands for the operating magnetic flux density where its output level varies from low to high.

*3: $I_{CCAVE} = \{I_{CCON} \times t_{ON} + I_{CCOFF} \times t_{OFF}\} / \{t_{ON} + t_{OFF}\}$

• Design reference data

Parameter	Symbol	Conditions	Min	Typ	Max	Unit
Hysteresis width	BW	$V_{CC} = 3\text{ V}$	—	7	—	mT
Supply current 3	I_{CCON}	$V_{CC} = 3\text{ V}$	—	1.4	2.1	mA
Supply current 4	I_{CCOFF}	$V_{CC} = 3\text{ V}$	—	2.5	—	μA
Supply current 5	I_{CC2ON}	$V_{CC} = 2.5\text{ V}$	—	1.12	1.68	mA
Supply current 6	I_{CC2OFF}	$V_{CC} = 2.5\text{ V}$	—	2.2	—	μA
Operating time	t_{ON}	$T_a = -25^\circ\text{C}$ to 75°C , $V_{CC} = 3\text{ V}$	10	26	42	μS
Stop time	t_{OFF}	$T_a = -25^\circ\text{C}$ to 75°C , $V_{CC} = 3\text{ V}$	258	644	1 030	μS
Operating time 2	t_{2ON}	$T_a = -25^\circ\text{C}$ to 75°C , $V_{CC} = 2.5\text{ V}$	11	27	43	μS
Stop time 2	t_{2OFF}	$T_a = -25^\circ\text{C}$ to 75°C , $V_{CC} = 2.5\text{ V}$	270	674	1 078	μS

Note) It will operate normally in approximately 0.67 ms after power on.

Individual Specification

■ Technical Data

- Position of a Hall element (unit in mm)

Distance from a package surface to sensor part: 0.31 mm (reference value)

A Hall element is placed on the shaded part in the figure.

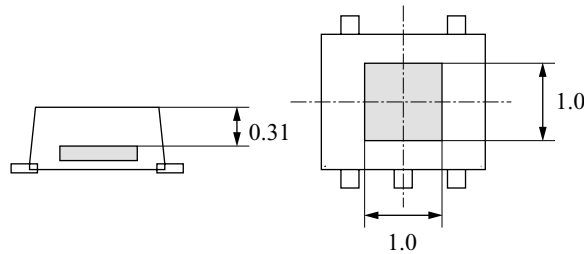

- Magneto-electro conversion characteristics

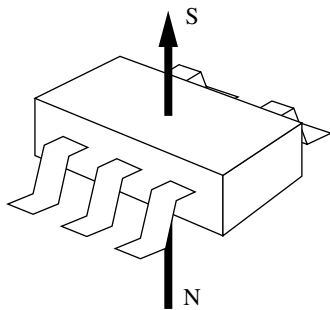

Direction of applied magnetic field

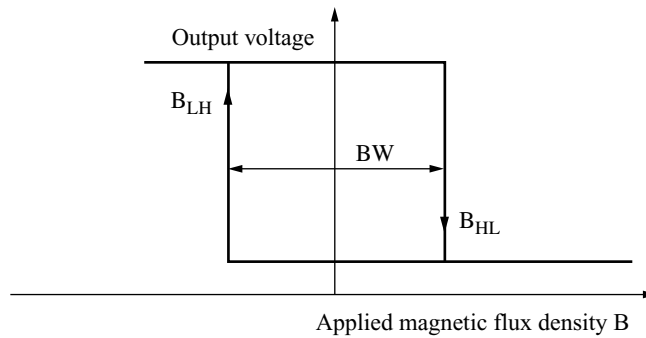

Operating magnetic flux density

- Power dissipation of package SMINI-5DA

$$P_D \text{ --- } T_a$$

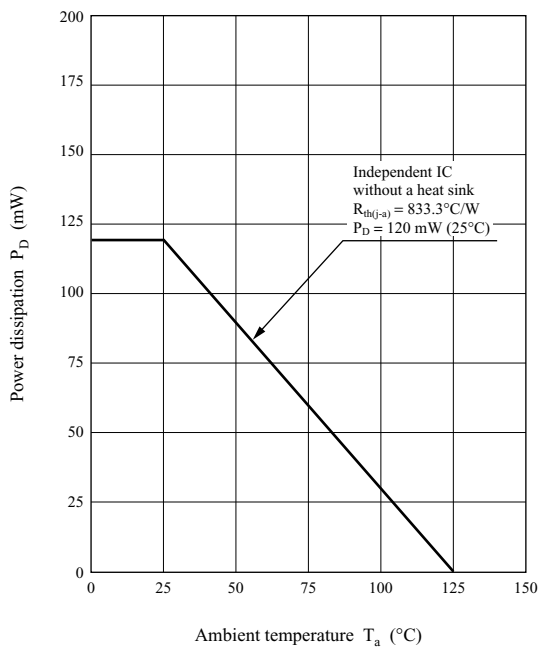

- Main characteristics

Operating magnetic flux density — Supply voltage

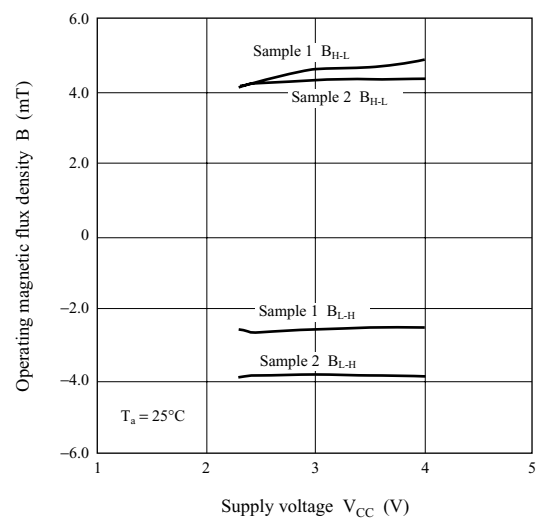

■ Technical Data (continued)

● Main characteristics (continued)

Operating magnetic flux density — Ambient temperature

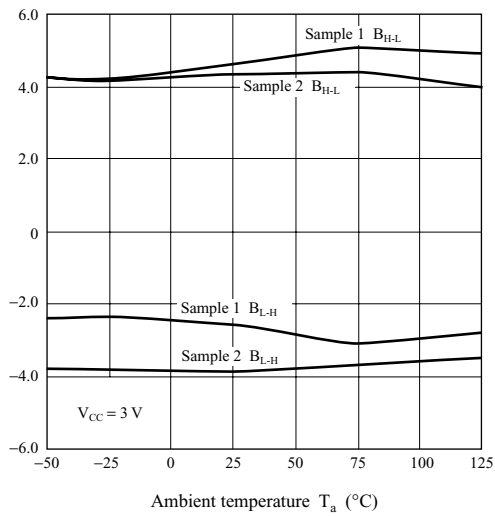

Hysteresis width — Supply voltage

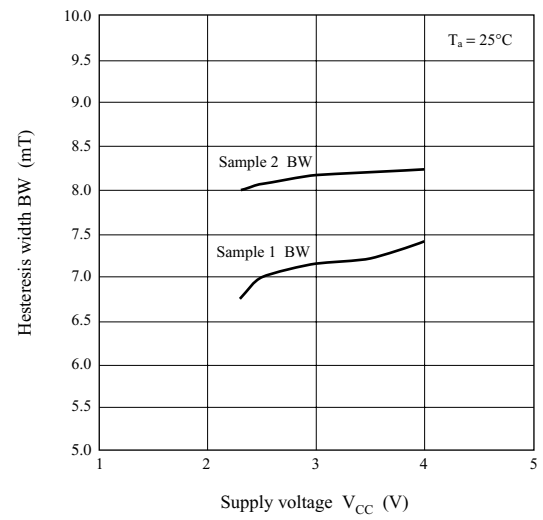

Supply current — Supply voltage

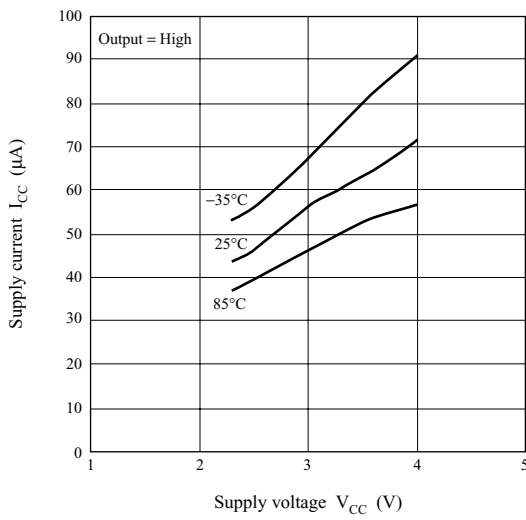

Low-level output voltage — Supply voltage

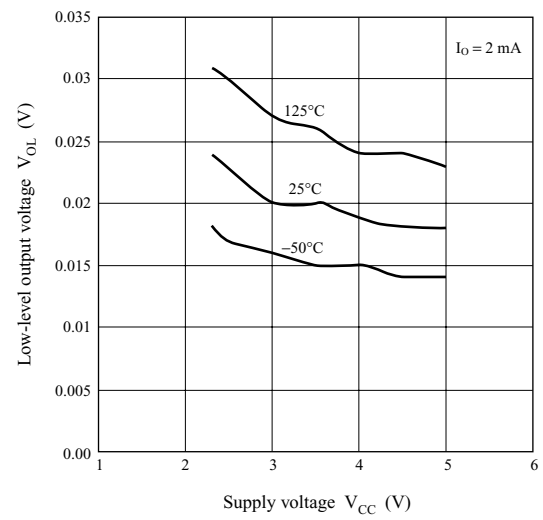

Δ high-level output voltage — Supply voltage

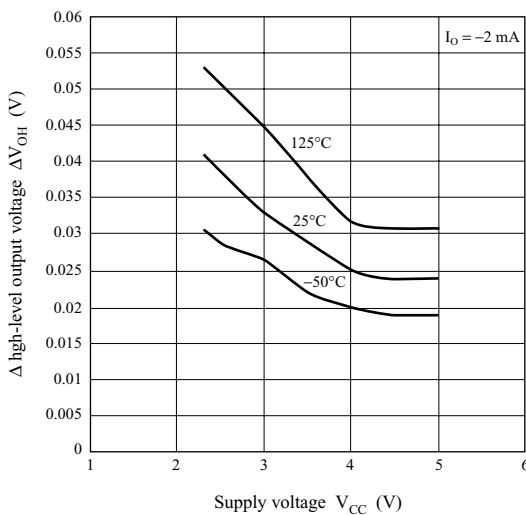

Sampling period — Supply voltage

